

2020-2021

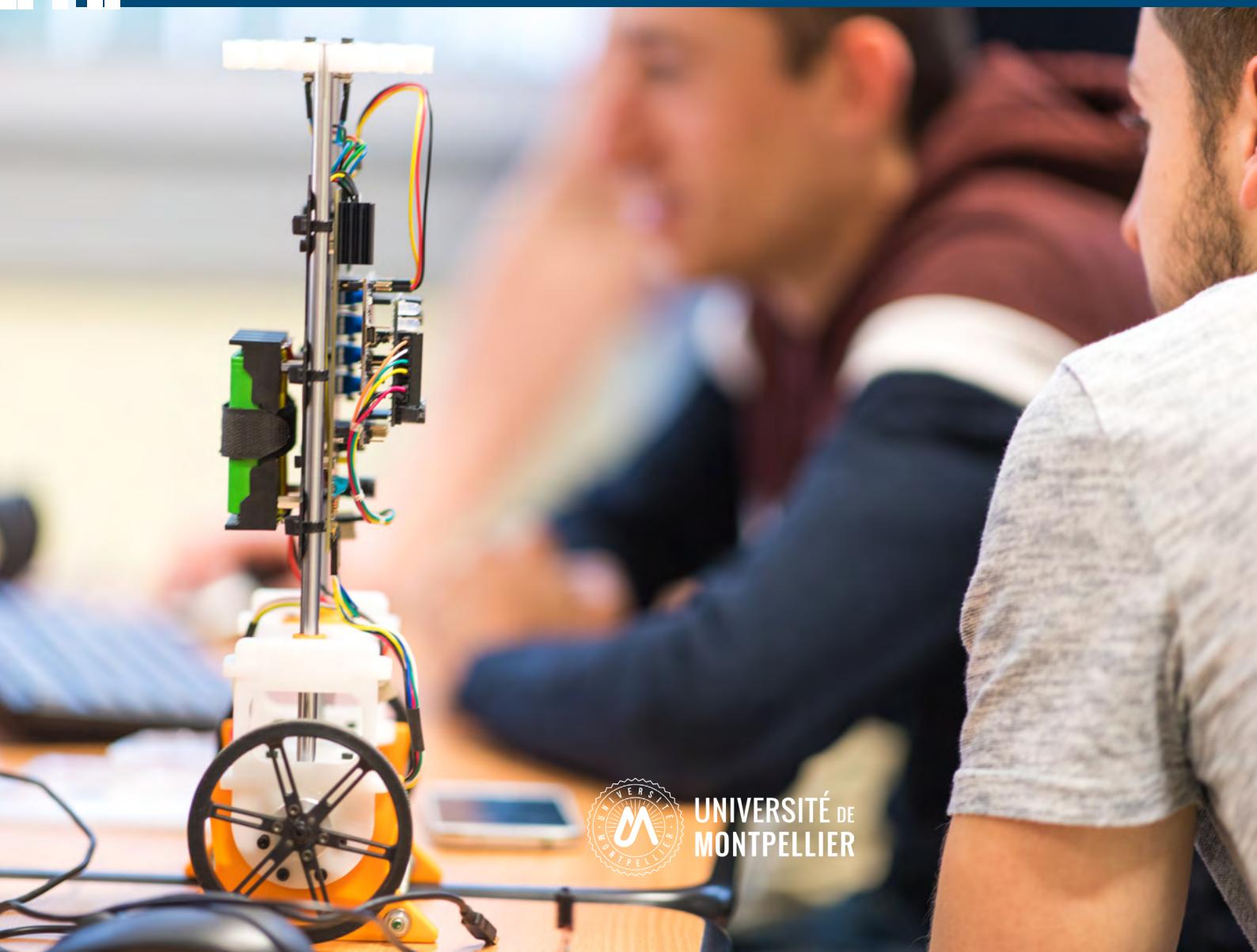

STUDENTS PROJECTS CATALOGUE



UNIVERSITÉ DE
MONTPELLIER

TRANSVERSAL PROJECTS



EGC



GBA



MAT



IG



MI



DO



MSI



SE



MEA



STE

Acquisition of an innovative beers production method integrating the mastery of kilning and brewing: application to the two cereals millet and barley



Alexis MATHIEU

Biological and Food Engineering
Materials

Alexis MATHIEU

Academic supervisors: C. CUNAUULT / C. STRUB



UMR IATE Agropolymer engineering & emerging technologies

Objective/Motivation:

This project is part of the development of know-how by the host laboratory on all stages of beer production including kilning, brewing and then carrying out fermentation. The three objectives were 1) to reproduce on millet and validate a kilning scale at 70 ° C, 2) adapt the brewing methods on 2 L brews and 3) conduct and test the repeatability of fermentation in mini reactors of 0.5 L

Results:

Thanks to the brewing protocol setting up in this projet, we are capable to brew in three 2L beaker in a row. The malting and kilning at 70°C were adapt with succes to the millet. The beers obtain after the fermentation prove the repeatability. The beers of millet obtained with this method have a pH of 4.12 ± 0.04 , with a EBC of 5.36, a lot of turbity and flavors of agrumes and jackfruit.

Keywords: Millet, brewing, malting, kilning

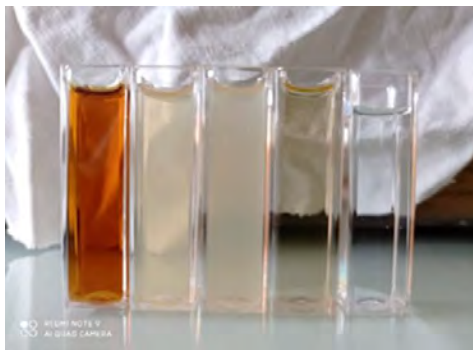

*Picture left : Turbidity of millet's beer(middle) compare to other beer ;
Picture right : Representation of brewing process*

Contact : alexis.mathieu.pro@hotmail.com

Development of packaging for a new chocolate product

Biological and Food Engineering
Materials

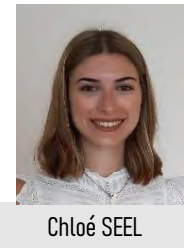

Chloé SEEL

Chloé SEEL

Academic supervisors: P. Chalier / J-P. Habas



Objective/Motivation:

The aim of this project is to develop packaging for a new chocolate product. This packaging must be adapted to the product, in particular, protecting it from shocks and breakage, but also from thermal and moisture fluctuation. This packaging must also comply with the company's CSR standard.

Results:

The packaging developed is called "the treasure box". It consists of a primary and secondary package. The former is a paper coated with vegetable wax is directly in contact with the chocolate and protect it from humidit. The latter, a flat cardboard box, allows the goupment of product in a batch of ten but also to protect it from mechanical and thermal shocks. The box is printed in the colours of a treasure chest with vegetable ink.

Keywords: Chocolate, packaging, protection, coated paper, cardboard box



The treasure box

Contact : chloe.seel@etu.umontpellier.fr

Bio-sourced materials: valorization of plant proteins for the development of micro and nanostructures

Materials
Biological and Food Engineering

Verquin Simon

Cassorla Julien

Academic supervisors:

Le Parc Rozenn /
Palmade Laetitia



IATE / L2C



Verquin Simon



Cassorla Julien

Objective/Motivation:

We are students very interested in chemistry and ecology in general. This project was the one that best suited our tastes. Moreover, it also allowed us to have a new eye in the field of materials because we didn't have many opportunities to be interested in this aspect of chemistry.

Results:

Through this project we were able to observe the evolution of the microstructure of our proteins following different treatments thanks to the study of Thioflavin Fluorescence and IR analyses. It was also observed that the modification of the microstructure had an impact on the macrostructure with notably the formation of aggregates observable by DLS.

Keywords: Patatin / rheologie / materials / Potatoe / structure

Contact : Julien.cssrl@gmail.com / verquin.simon@hotmail.com

Characterization of NiTi wire, a shape memory alloy used for aortic stent

Materials
Mechanical Engineering and Interactive Design

Loriane Poirot Emile Bonny

Academic supervisor: H. Louche



LMGC = Laboratoire de mécanique et génie civil
(Mechanical and civil engineering laboratory)



Emile Bonny

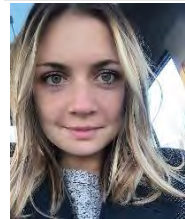

Loriane Poirot

Objective/Motivation:

The aim of this project is to characterize wires, arches and rings used in a stent aortic manufactured by a cardiac surgeon and compare them to stents commercialized by Medtronic company. We have carried out different tensile tests on wires having undergone different heat treatments (time, temperature).

Results:

Thanks to a tensile testing machine, we have made cycles of loading and unloading to evaluate the mechanical behavior. We have tested parts of the surgeon's stent for different treatment times and temperatures. We observed similar behaviors between the surgeon's and Medtronic's stents. We then showed that the ideal treatment was 500° C for 20 minutes and not 450°C for 20 minutes as previously assumed.

Keywords: stents, shape memory alloy, surgery, mechanical, materials

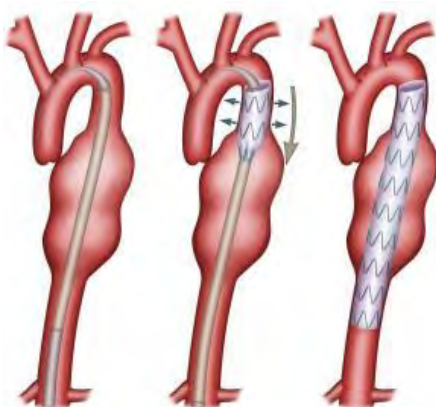

On the left : a stent being deployed in the aorta artery / On the right : the instrumentation set up for mechanical characterization

Contact : loriane.poirot@etu.umontpellier.fr ; emile.bonny@etu.umontpellier.fr

Design & development of a robotic hand simulator controlled through a wireless link

Computer Science and Management
Microelectronics and Automation



Enzo Rosarini

Enzo Rosarini

Academic supervisors: D. Andreu / P. Fraisse



Neurinnov

Objective/Motivation:

The goal of this project is to allow quadriplegic persons that are eligible for Hand Stimulator (HandyGrasp™), to practice the control of the simulator. In fact, there are different modules that can control the hand stimulator, one of them is a shoulder movement detection. To use it correctly, the patient needs to know which shoulder movement to perform to correctly open / close his hand.

Results:

The Simulator is able to establish a connection with the movement sensor to receive commands. It is possible to set the target object to grasp. Once set, the module can send commands depending on the user's movement. If the command given by the user is the right one, it will grab the object, otherwise the hand will move without grabbing the object.

Keywords: Health, Hand, Simulation, Robotics, 3D, Bluetooth, Informatics C/C++

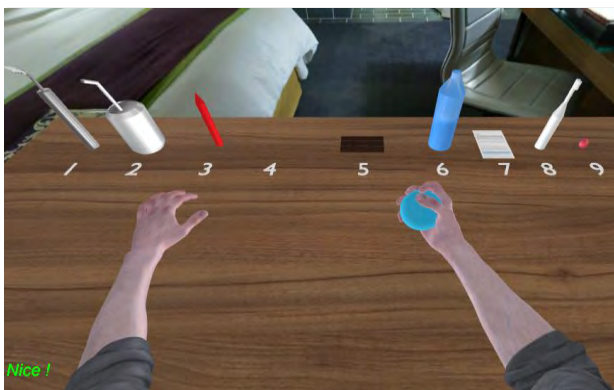

HandySim Demo Screenshot

Contact : enzo.rosarini@etu.umontpellier.fr

Design and prototyping of a device for measuring the muscular efforts of a hand under electrical stimulation

Microelectronics and Automation
Mechanical Engineering and Interactive Design

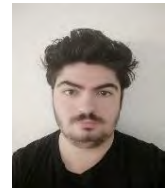

T. Robert



J. Bonnafoux

Bonnafoux Julie

Théo Robert

Academic supervisors:

D.Andreu / P.Fraisse



Polytech Montpellier / Neurinnov

Objective/Motivation:

The goal of the project is to create a device that allows to measure the force exerted by a hand under electrical stimulation when it closes and opens, without taking an object.

Results:

Our final solution was designed in SolidWorks and 3D printed. It is made up of different pieces that can be moved relative to each other. These parts are attached via pivots and torsion springs make it possible to stiffen the device. In order to determine the angles between the different phalanges, we measure the angles by means of Inertial Measurement Units. Knowing the stiffness of the springs, the different distances between the pivots and the angles of the phalanges, we can compute the joint torques of the fingers.

Keywords: Muscular Effort, Hand, angle measurement, Mechanical Design, 3D Printing

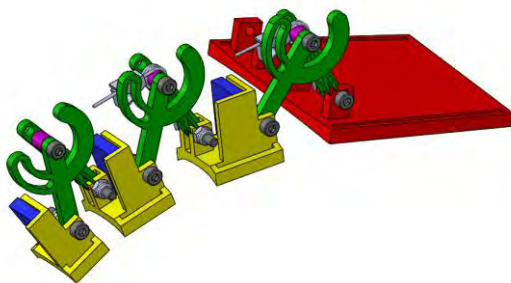

Contact : theo.robert@etu.umontpellier.fr ; julie.bonnafoux@etu.umontpellier.fr

Design and prototyping of an automated system managing a tube filling process for PCR testing

Mechanical Engineering and Interactive Design
Microelectronics and Automation

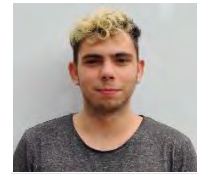

Joey DAGAUD

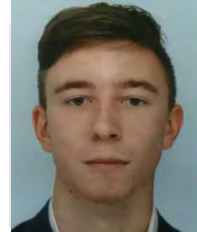

Kévin BELBEY

Kévin Belbey Joey DAGAUD

Academic supervisor: Guy Cathébras



Polytech Montpellier / Bioaxiome

Objective/Motivation:

The objective of this project is to design and prototype an automated system that could manage the process of filling tube for PCR testing of Bioaxiome Laboratory based at Nimes. I worked with a student from Mechanical Engineering and we had to design a global solution regarding constraints imposed by Bioaxiome.

Results:

We found a global solution based on a Delta robot. With solutions for screwing module and filling module that we had to study the faisability. We made and we controlled the Delta robot by controlling smart motors.

Keywords: Programming, PCR test, Robotics, 3D printing, Fonctionnal analysis, Smart Motors

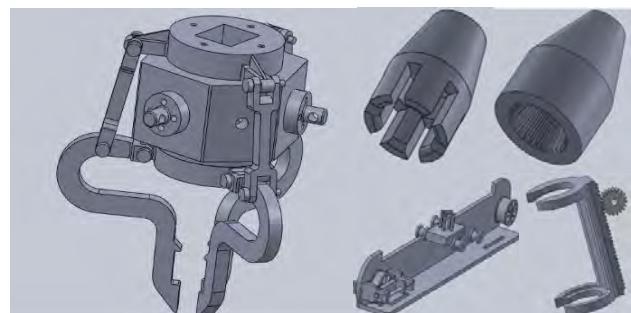

Robot Delta / Logiciels utilisés / Modèles 3D des solutions techniques

Contact : joey.dagaud@gmail.com ; belbeyk@gmail.com



The biological treatment of nitrogen and phosphorus and the different types of proccessus

Water and civil Engineering

GROSJEAN Gaétan

Academic supervisor: D. BOUYER



Polytech Montpellier / SAUR

Objective/Motivation:

The purpose of this project is to size a wastewater treatment plant to biologically treat nitrogen and phosphorus.

Results:

Biological nitrogen treatment is easily achievable for free-growing wastewater treatment plants. Sizing rules must be respected

The biological treatment of phosphorus is complex. It must often be followed by a physicochemical treatment to meet the discharge standards

Keywords: Phosphorus ; Nitrogen ; Waste water ; Treatment plant



Contact : gaetan.grosjean@etu.umontpellier.fr

Contribution of porosity models to flood's modeling of shallow river



CRISSOT Simon

Water and Civil Engineering



Academic supervisor: DELENNE Carole

Polytech Montpellier - Hydrosiences Montpellier

Objective/Motivation:

Apply to a Luxembourg's river a flood modeling with a 2 dimensions and porosity model and compare results to an already designed 1D model (with the HEC-RAS software). Fields data are available to further validate the model.

Results:

Construction of a rough mesh of the study zone (figure 1)

Comparaison of the field data with the calculated data

Display of the flood on several maps (figure 2)

Keywords: Modeling / Floods

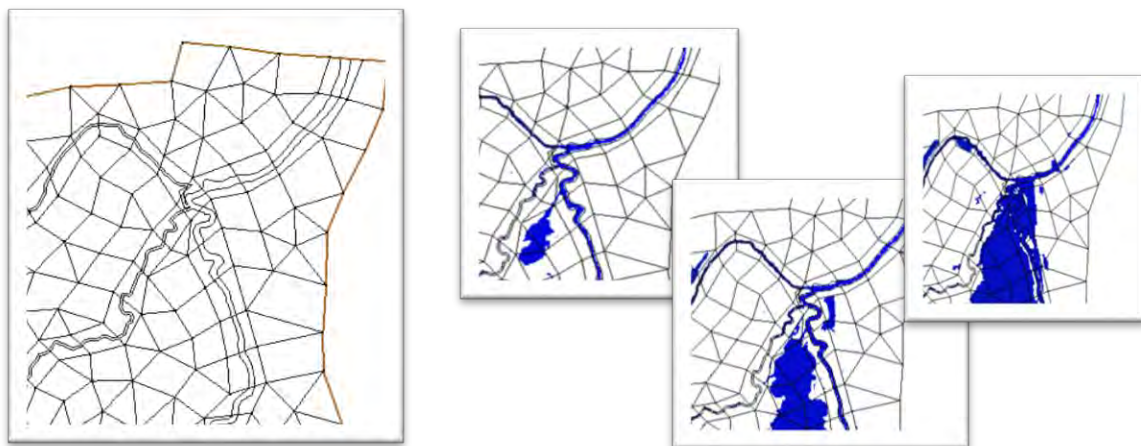

Contact : simon.crissot@etu.umontpellier.fr



Redaction of a guide aimed at agri-food companies

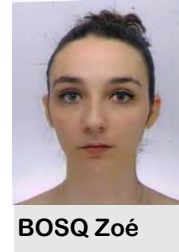

Biological and Food Engineering

Zoé BOSQ

Academic supervisor: Anne GERARD



AREA Occitanie

Objective/Motivation:

Redaction of a guide made in the goal to inform agri-food company about recent laws (EGALIM/AGEC) which can impact them, and also about Territorial Food Project (TFP). Other missions : Informing consumers via social networks about agri-food companies of the Occitanie region.

Results:

1) Creation of the guide, 2) Organisation of a webinar [which goal was -more or less- to present the guide], 3) redaction and of two posts per week in the goal to promote companies and inform consumers about topics related to their food.

Keywords: Guide - Laws - Communication via social networks (publications on Facebook).

Contact : zoe.bosq@etu.umontpellier.fr

Support in setting up the quality system of WeMed

Biological and Food Engineering

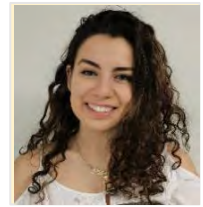

CAMEL Clara

Clara CAMEL

Academic supervisor: Delphine ESPI



WeMed (Company specialised in Medical Devices)

Objective/Motivation:

The missions I tried to accomplish were offered by Emmanuel SAINT MARTIN, an associate of the start-up WeMed. He was in need of someone that would work full-time on implementing the quality system of the company. In 2019, Cyrille LECROQ, the CEO, designed an innovative 3D-printed and connected stethoscope. The associate set an ambitious goal : to launch the Skop in early 2021.

Results:

Starting from scratch, I drafted the basis of the documentation system and achieved my main objective which was writing the Quality Manual. I also took part in various tasks from project management with establishing the planification (Gantt) for market autorisation to the drafting of human factors test protocols.

Keywords: Medical Device, Quality, QMS (Quality Management System), Start-up



Representation of The Skop - 3D-printed connected stethoscope

Contact : claracamel@yahoo.com

Organic fermentation in brines of olives



Mille Marie

Biological and Food Engineering

Marie Mille

Academic supervisor: A. Colas



Polytech Montpellier/ Qualisud / Controlwatt

Objective/Motivation:

The issue of this project was to perform organic fermentation of several varieties of olive. The varieties studied were Aglandau, Bouteillan, Lucques and Picholine. The aim was to determine the influence of some fermentation parameters such as temperature, salt concentration of the brine, agitation or presence of cuts on olive. In order to study this influence, pH, phenolic compounds, β -glucosidase activity, microbiological analysis and HPLC analysis were assessed.

Results:

Yeasts were founded in all bacht of fermentation but no β -glucosidase activity was detected in brines. Salt concentration in brine doesn't influence the efficiency of fermentation contrary to temperature, agitation or cuts in olive. All of these settings influence the process but it depends of the variety of olive that is fermented. Finally, the effience of the fermentation process really depends on the variety used for fermentation.

Keywords: olive - fermentation - enzymatic activity - acidification - phenolic compounds -



*Photo of Lucques olives (on the left);
Photo of some fermentation bacht incubated at 30°C (on the right)*

Contact : marie.mille@umontpellier.fr

Ecotrophelia

Biological and Food Engineering

Noémie Fayolle
Thaïs Savelon



Ecotrophelia France

Objective/Motivation:

Ecotrophelia France is a competition that challenges student teams to create the most innovative and sustainable food products, from laboratory design to industrial simulation. Prizes are awarded each year. This year, our team chose to work on the Meat prize.

Why meat? Although its industrial production and consumption are now widely criticized, meat remains widely consumed and greatly appreciated. Moreover, many food innovations try to imitate it, but few manage to make their alternatives successful.

Our idea is to offer consumers high-quality meat and to have them associate it with the current vegetal food trend. We aim to help consumers transition towards healthier and more environmentally-friendly food habits: switching from a 100% animal diet to a mixed animal/vegetal one. This innovation is ecoconceived and should allow beef producers and distributors to enter the appetizers market.

Results:

Our innovation is a legume-covered stick of dried meat. It provides a crunchy texture and a unique taste. We carefully selected 3 legumes: green lentils, chickpeas and split peas; they offer a variety of colors and flavors, which harmoniously combine to make this product esthetically attractive and intriguingly tasty.

Moreover, we season the sticks with different spices to come up with a range of tastes from around of the world :

French Fields : Lentils and Provençal Herbs

Indian Spice : Split Peas and Curry

Lebanese Mystery : Chickpeas seasoned with Garlic and Parsley

Finally, this product has a real nutritional interest, unlike the traditional appetizing meat, and is Nutriscore A. Indeed, the chosen meat is low in fat and is an undeniable source of protein, just like legumes which also provide fibre and complex carbohydrates.

Keywords: meat, legumes, appetizer, innovation, ecoconception, DDRS



The team - Our 3 products



Noémie Fayolle

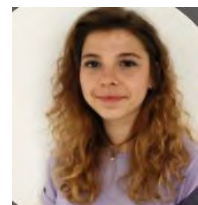

Manon Vidal



Ophélie Soules



Thaïs Savelon

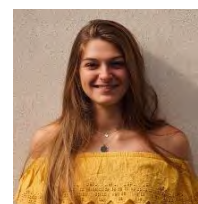

Lyne Thimonier



Laura Chanoni

Contact : ecotrophelia.polytechmtp@gmail.com

Effects of high static pressures on the techno-functional properties of patatin



Emma CANONGE

Biological and Food Engineering

Emma CANONGE

Academic supervisors: L. PALMADE



Montpellier University UMR IATE

Objective/Motivation:

Use of High Pressures as a means of modifying patatin, a vegetable protein obtained from potato juice, which is by-products of the starch industry. Patatin is a vegetable alternative to animal proteins, and as a by-product it is interesting to study its properties with a view to valorization in the food industry.

Results:

The 30-minute and 2-hour HP treatments at 400 MPa modify the structure of the protein and therefore have effects on the techno-functional properties of the patatin. However, the HP-induced increase in foaming capacity is slight. The HP does not allow an improvement in the stability of the mouses. HP treatments improve the gelation of 10% patatin solutions

Keywords: Vegetable proteins, high pressure processes, techno functional properties

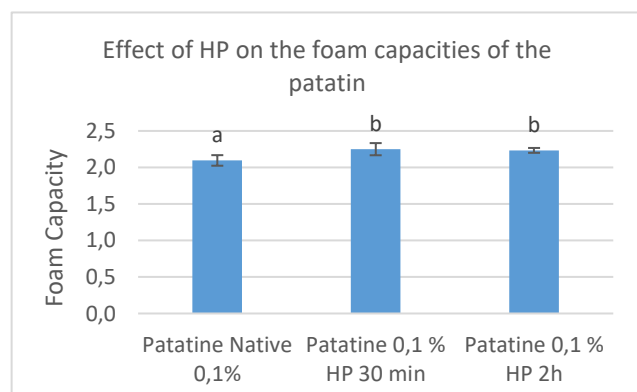
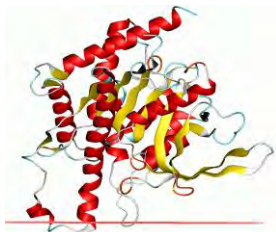

Contact : emma.canonge@etu.umontpellier.fr

Regulatory monitoring



Klein Emma

Biological and Food Engineering

Emma Klein

Academic supervisors: Alexandre Colas de la Noue



Wine cooperative Labastide

Objective/Motivation:

Creation and completion of an Excel file dedicated to regulatory monitoring
First, creation of the Excel file (determination of the number and content of columns) Search on two databases for regulatory texts concerning wine
Reading texts and extracting the main regulatory requirements

Results:

Addition of new regulatory texts published in 2021
Optimization and improvement of the file following its use

Keywords: Wine - regulatory texts - regulatory monitoring

Contact : emma.klein@hotmail.fr

Development of a process to optimize flour mixing



Mathis LOLLIOT

Biological and Food Engineering

Academic supervisor: Alexandre COLAS DE LA NOUE



Moulin de Sauret

Objective/Motivation:

The company equipped itself with two new vertical screw mixers so a process had to be developed to optimize the mixing times of the flour while ensuring their quality. The idea was to study all the parameters that have an influence on the homogeneity of the mix : the mixing time, the type of flour, the amount of flour to mix, the order of introduction of ingredients and the status of improvers (premix or bulk) in order to create a summary table for operators.

Results:

It appeared that it is always better to introduce improvers first and the flour after. For the other parameters, the monitoring of relevant indicators such as protein content, water content, ascorbic acid level, ash content or Hagberg falling number allowed to find the better way to mix and draw up the following table.

Keywords: Process, mix, flour, homogeneity, quality

Flour	Amount (kg)	Order of introduction	Parameters	Number of cycles	Type of cycles
Le Cevenol	0-3000	Improver Flour	120s Looping 600s Mixing	2	Looping Mixing Looping Mixing
All except Le Cevenol	0-3000	Improver Flour	60s Looping 300s Mixing	1	
All if improver at the end	0-3000	Flour Improver	120s Looping 900s Mixing	2	
La Festive Festival Tentation La Sauret Festival Tradition Locale Typique 80	3000-6500	Improver Flour	60s Looping 600s Mixing	1	
All if improver at the end	3000-6500	Flour Improver	300s Looping 900s Mixing	4	

Mix process for the 2 mixers

Contact : mathis.lolliot@outlook.fr

Optimization of NK cells expansion protocol and application on metastatic cells



TORQUET
Mathieu

Biological and Food Engineering

Mathieu Torquet

Academic supervisors: D. Gitenay



IRMB (Institute for Regenerative Medicine & Biotherapy)

Objective/Motivation:

Innate immune system produces Natural Killer cells which recognize cancerous cells through two types of membrane receptors. KIR receptors detect that one of the regular MHC 1 proteins is missing, which is typical of cells infected by viruses or cancerous cells. And NKG2D receptors detect the presence of stress markers induced by EMT which is a necessary step for metastasis proliferation. Until today, our laboratory NK cells expansion protocol uses only one accessory cell line (PLH line) and interleukins to activate and induce NK cells differentiation. However, the obtained pool is heterogenic, and all NK cells are not activated nor possess every receptors of interest. Thus, the objective of this project is to optimize this expansion by using multiple accessory cell lines during culture to obtain a homogenized final pool of active NK cells with all receptors of interest.

Results:

Unfortunately all NK cells expansion failed during this project. Nevertheless, this project made me acquire a lot of theoretical knowledge on cell culture and NK cells especially. I also participated on a second project focusing on the effect of NK cells on metastatic cells where results have been obtained.

Keywords: Biology, Immunology, Natural Killer, Cells, Culture, Cancer, Optimization, Research

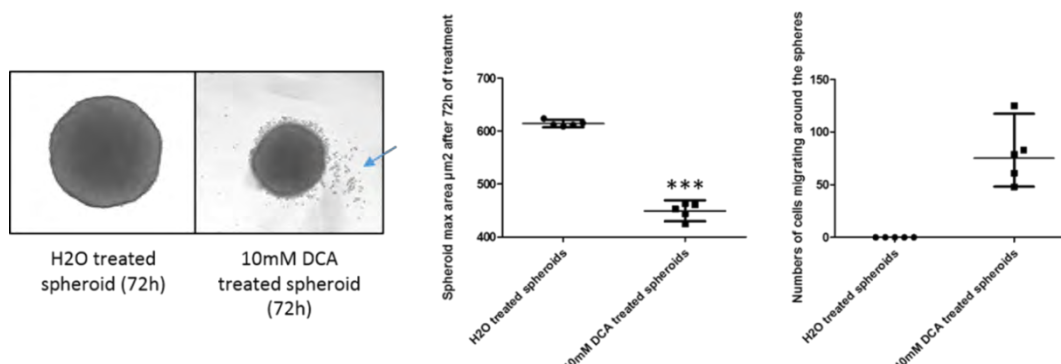

Effect of DCA on the ability of HCT 116 cells to undergo metastatic process

Contact : mathieu.torquet@etu.umontpellier.fr

Implementing of a tempe production method and characterization of the final product



Rose Bruder

Biological and Food Engineering

Rose Bruder

Academic supervisors: C. Cunault / C. Strub



IATE / QualiSud

Objective/Motivation:

The feasibility of a tempeh production from unhulled soybeans has been tested. The process steps carried out were: acidic seed soaking for 15 hours at 30°C, dehulling, cooking, inoculation of the *Rhizopus oligosporus* strain, vacuum packing and micro-aerobic fermentation. The parameters that were studied were: cooking time and temperature, fermentation time and temperature. The cooking process were executed at 100°C for 30 minutes or at 100°C for 2 minutes then 121°C for 2 minutes. The fermentation were carried out at 30°C or 37°C for 26 hours or 45 hours.

Results:

The thermal treatments at 100°C then 121°C were more destructive towards the microorganismst. It is also during this step that the diffusion of componants through the water was the greatest. The 30°C fermentation temperature showed more moulds and yeasts but had a less appreciated taste than the 37°C fermentation. The tempehs that were fermented for 45 hours were firmer, had a more important *Rhizopus oligosporus* mycelium and had better organoleptic properties. Finally, the tempehs had 22,18% of proteins, 0,52% of soluble carbohydrates, 8,12% of lipids, 0,01% of ashes and 34% of dry matter.

Keywords: tempeh, soybeans, *Rhizopus oligosporus*, fermentation, characterization, proteins, carbohydrates, lipids



Contact : rose.bruder@etu.umontpellier.fr



Chatbot Jira

Computer Science and Management

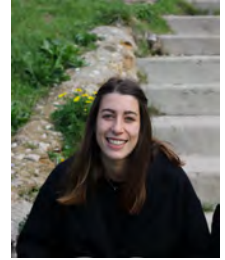

Emma
CABARET

CABARET Emma

RABESON Weslie

ANDREU Paola

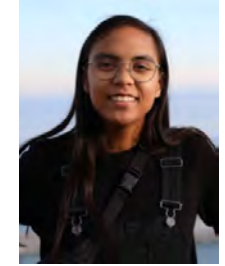

Weslie
RABESON

Academic supervisor:

STRATULAT Tiberiu

sopra steria

Sopra Steria



Paola
ANDREU

Objective/Motivation:

Creating a conversational chatbot in order to help users of Jira to create, update and manage tickets, by giving advice and directions as to what should be filled in. We define users as "clients", "devs", "product owner", "scrum master" etc., and each one of them might have a different discussion with the bot. To achieve this, we are using a tool provided by Sopra Steria called Alive Intelligence.

Results:

We designed 23 conversational trees to model the conversations between a bot and a user who wants to perform actions on Jira through the bot.

We implemented 17 conversational scenarios that will allow users to connect to the bot and communicate to Jira through it. The user is now able to create, edit and read tickets, as well as creating, editing, reading and deleting search filters using the request language of Jira (JQL). The communication between the bot and Jira is done with the use of API calls, using REST verbs (get, post, put, delete) to directly modify info about the connected user's work on Jira.

We finally ran around 50 tests through the Botify testing tool, around 160 qualification tests to make sure our scenarios were correct, and overall tested the entirety of our scenarios to ensure a pleasant user experience.

Keywords: Jira Software, conversation tree, API, Alive Intelligence

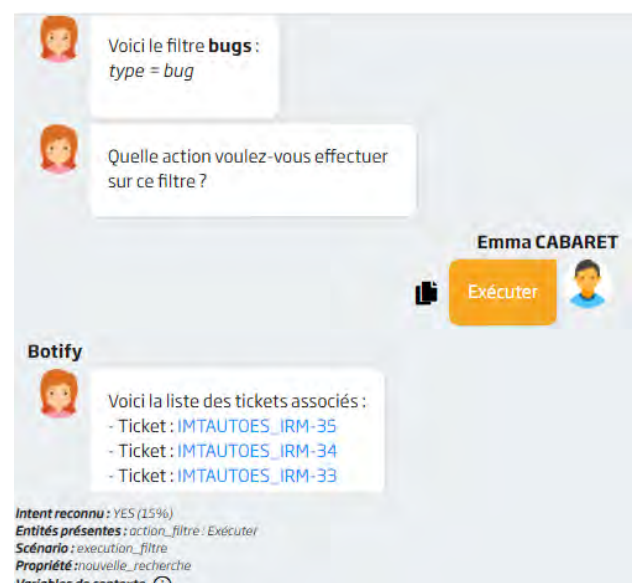
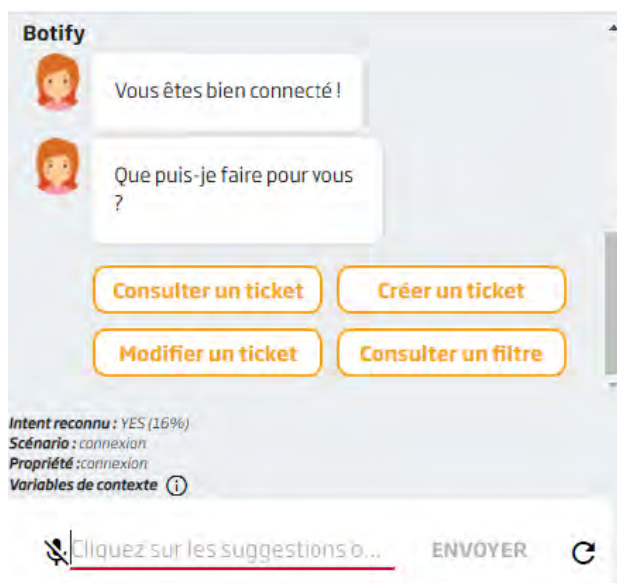

Screenshot of the conversation with the bot.

Contact : emma.cabaret@etu.umontpellier.fr; weslie.rabeson@etu.umontpellier.fr; paola.andreu@etu.umontpellier.fr

Cyleone Dashboard



Alexis Andre

Computer Science and Management

Alexis Andre

Jeremie Dumont

Alexandre Girbal

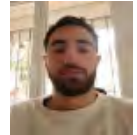

Jeremie Dumont



Alexandre Girbal



Academic supervisor: Christophe Fiorio

Cyleone

Objective/Motivation:

The goal of the project was to fetch data of multiple services used by the company such as Google Calendar, Pipedrive, Evoliz, Jira, Google Analytics. Once fetched those data needed to be displayed on a website wick only authenticated staff could access.

Results:

The result was as expected, we even added the possibily to limit acces to some elements of the website depending of there administration level of the authenticated user (an admin having more rights than a superuser, this superuser having access to more data than a simple user). The authentication has been secured by keycloak and the keycloak server as been set so it can be reused for other projects.

Keywords: Dashboard, web, vue, vuejs, nuxt, keycloak, docker, php, symfony, api, apis, responsive, auth, authentication, integration, Google Calendar, Pipedrive, Evoliz, Jira, LinkedIn, Facebook, Twitter, Google Analytics, frontend, backend



Screenshot of the dashboard with all rights (fig1) and nd with less rights (fig2)

Contact :

alexis.andre@etu.umontpellier.fr jeremie.dumont@etu.umontpellier.fr
alexandre.girbal@etu.umontpellier.fr

Implementation of a Widget System on the TRF Retail Homepage

Computer Science and Management

Hugo BRANDO Dorian LAURANCY

Academic supervisor: Vincent BERRY



Hugo
BRANDO

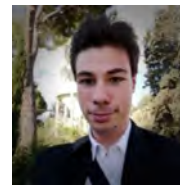

Dorian
LAURANCY

Objective/Motivation:

TRF Retail, a company located in Nîmes, France, offers a SaaS solution to retail companies so that they can optimize and control their assortment and their commercial offer. Within the TRF Retail team, the students mission was to set up a "Widgets" module that allows TRF Retail users to manage components summarizing their activity on their home page.

Results:

The homepage, which was previously empty, now offers to display widgets according to the profile and preferences of the user. The latter can at any time modify the layout, size and content of the widgets in order to display the most relevant information for him, in a condensed and simple form.

Keywords: Widgets, Saas, Home page, Dashboard, Retail, Business intelligence, Full stack web development, Design, Web, VueJS, Vuetify, Mysql, MariaDB, NodeJS, Visualization, Statistics, Analysis, Development, JavaScript, TypeScript

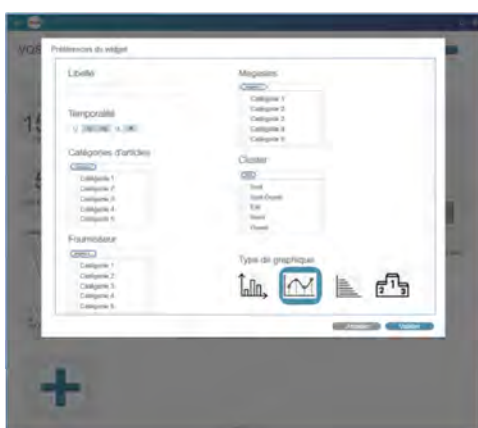

Widget Dashboard in the Homepage

Contact : <https://www.linkedin.com/in/hugo-brando/> ; <https://www.linkedin.com/in/dorian-laurancy/>

Recist

Computer Science and Management

Héloïse Sanchez

Arthur Leblanc

Pierre Partinico

Academic supervisors: Anne-Laure Villaret /
Chouki Tibermacine



Dr Hichem TIBERMACHINE - independent radiologist (in collaboration with the Oncology Institute Of Montpellier)



Sanchez



Leblanc

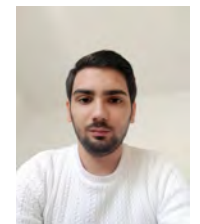

Partinico

Objective/Motivation:

The objective of our final year industrial project was to build a web application dedicated to health workers, in order to monitor the evolution of patients affected by cancers. This application being intended to be used for medical purposes, we had to face a lot of constraints such as the ease, for health workers to read data related to their patients, or the data security.

Results:

We developed three interfaces. The first one is intended to be used by administrators to manage health workers and patients accounts, and data related to them. The second one will be used by health workers to monitor patients accounts and their medical records. Finally, we developed an interface for patients, to allow them to visualize their demographic data and records.

Keywords: Web, Javascript, NodeJS, React, Medical, Cancer



Prénom: Test
 Nom de famille: Patient
 Adresse mail: test@mail.address
 N° de téléphone: 0600000000
 Sexe: Homme
 Date de naissance: 01 Janvier 2000

Dossier n°1 - Organe touché: Coeur

VOIR LES DONNÉES RADIOLOGIQUES MODIFIER LE DOSSIER



Contact : heloise.sanc@hotmail.fr ; arthurleblanc11@gmail.com ; pierre.partinico@gmail.com

Query generator for CRM

Computer Science and Management



Lucas Paulin

Guillaume Tessier Lucas Paulin

Academic supervisors: A. Castelltort



Camatau

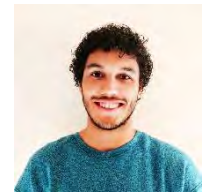

Guillaume Tessier

Objective/Motivation:

The objective of this PIFE was to develop a CRM tool in order to complete SinGeBill's offer and to allow its users to efficiently segment their database in order to carry out targeted marketing actions.

Results:

We have developed a "query generator" tool to create customized queries. This generator allows to select the data to be retrieved, to create complex filters and then to display and export the data. Queries can be saved and reused later.

Keywords: CRM, Query, Typescript, Angular, NodeJS, PostgreSQL

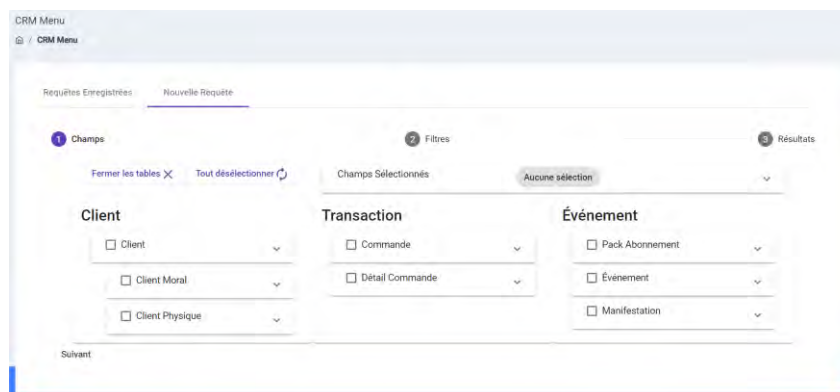

Query generator : field's selection

Contact : lucas.paulin@etu.umontpellier.fr ; guillaume.tessier@etu.umontpellier.fr

Carbon footprint interface for international mobility Polytech

Computer Science and Management



IG



Polytech department RI and DDRS

Felix Potié

Mathis Bourrat

Simon Gayet

Academic supervisors:

I. Bourdon



Potié



Bourrat



Gayet

Objective/Motivation:

This project aims to set up an IT interface, or an application, dedicated to data entry, calculation and monitoring of the carbon footprint related to the international mobility of Polytech students. To carry out this project, you will be in contact with the quality engineer, the DDRS referent, the international relations (IR) department and the Polytech's IR delegate director.

Results:

We created a web application named MOBILAN. We done it with Reactjs connected to a Postgres database via a REST API NestJs. This solution allows Polytech students to register their mobility, it also integrates a data visualization table and an administrator space.

Keywords: APP WEB DDRS RI STUDENT CARBON FOOTPRINT API DATA POLYTECH NESTJS

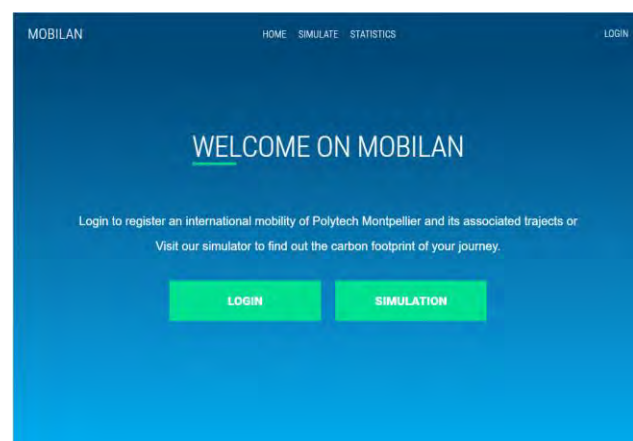

Contact : felix.potie@etu.umontpellier.fr mathis.bourrat@etu.umontpellier.fr gayetsimon@gmail.com

IOTOOLS – web application

Computer Science and Management

Justine Foulquier

Rémi Salmi

Camille Thomas

Academic supervisor:

Eleonora Guerrini



Iotools Systems



Justine Foulquier

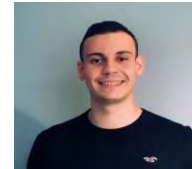

Rémi Salmi



Camille Thomas

Objective/Motivation:

Industrial vehicle tires are equipped with sensors that measure parameters such as pressure, temperature, tire wear and speed. This allows the customer to monitor his equipment and improve its use.

The web application should allow to synthesize all this information. A first version of the application exists, we need to modify some features and bring new ones.

Results:

A functional, documented and hosted web application that meets all the expectations of our applicants.

This application should be compatible and consistent with the mobile application that the other group (IOTOOLS - mobile application) implements.

Keywords: IOT – web application – industrial vehicules – tires



Contact : justine.foulquier@etu.umontpellier.fr ; remi.salmi@etu.umontpellier.fr ;

Ippon : Analysis & Retranscription of videoconferences

Computer Science and Management

Anthony Dupré

Garira Moundi Mazou

David Meier

Academic supervisor: Lysiane Buisson-Lopez



Ippon technologies

Objective/Motivation:

The mission consists of a research project around the retranscription of a videoconference. Our goal is to make audio transcriptions of online meetings in text. The objective is to be able to transcribe in semi-real time (captioned with a few seconds of delay) the meetings carried out on any video conferencing platform.

Results:

State of the art, functional specifications, prototype of the solution with a GitHub user guide.

Keywords: Machine Learning, Data, Cloud, Python, AWS

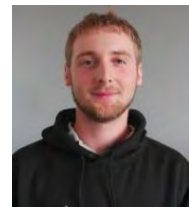

David Meier

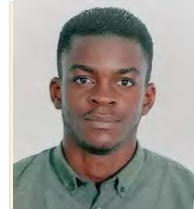

Garira Moundi Mazou



Anthony Dupré



Google APIs

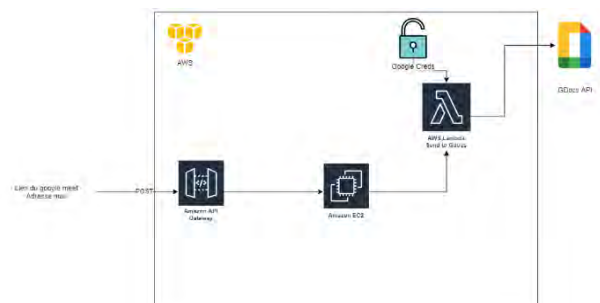

Project technologies and architecture

Contact : david.meier@etu.umontpellier.fr ; garira.moundi-mazou@etu.umontpellier.fr ; anthony.dupre@etu.umontpellier.fr

Peach



Debeir Luca

Computer Science and Management

Debeir Luca Faure Thomas Niort Hugo

Academic supervisor: Chapellier Philippe

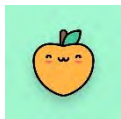

Peach



Faure Thomas



Niort Hugo

Objective/Motivation:

HappyPeach développe l'application de suivi de traitement médical Peach. Cette application a pour but d'accompagner et de motiver des patients à rester réguliers dans la prise de leurs traitements. Pour cela l'application récompense les utilisateurs ayant une bonne observance thérapeutique en leur offrant des réductions chez les entreprises partenaires.

Results:

Correction de certains problèmes de l'application, mise en place d'espaces publicitaires et de l'abonnement premium. Amélioration de l'interface utilisateur.

Keywords: mobile, application, ios, android, react-native, firebase, medical

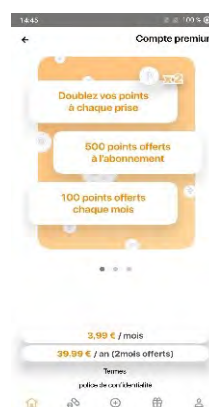

Contact : luca.debeir@etu.umontpellier.fr; thomas.faure01@etu.umontpellier.fr; hugo.niort@etu.umontpellier.fr

Neurinnov

Computer Science and Management

Rayan Bahroun Amjad Menouer Mitantsoa Ranarimahefa

Academic supervisor: Philippe Chapellier



Neurinnov

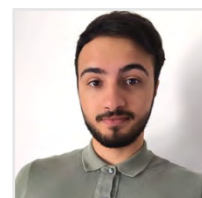

Rayan

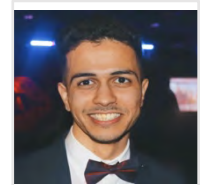

Amjad

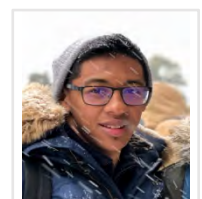

Mitantsoa

Objective/Motivation:

Improve the actual software of Neurinnov, so the database can be used and reused with no problems, design the busi logic of the application and think of each components so it can be put or removed without any crash. Implement 3 mai fonctionnalités : a History of each modification, a 3D modelisation of the device and a Graphic User Interface for the microprogram management.

Results:

We made a review of the code, and of the design of the data system. Then we made a huge refactoring so the softwa can't crash because of a bad access to the data. At the end, we finally implemented the 3 functionalities. The history w the GUI for the microprogram works too but can be improved and the 3D Modelisation works but shows no color (beca of a lack of data ressources to visualize the texture).

Keywords: Medical device, Database, Human-Computer Interaction

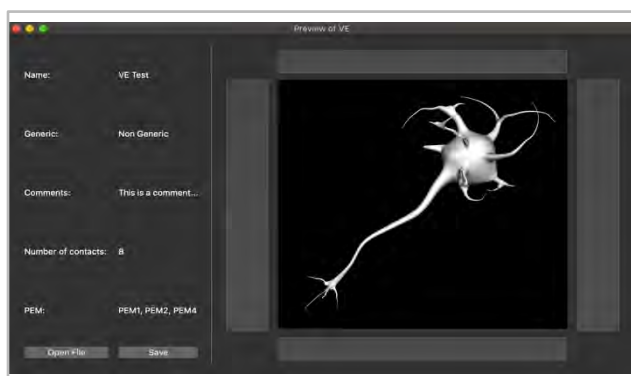

Interface for a 3D Simulation (at the left) - Graphical View of the Microprogram Instructions (at the right)

Contact : r.bahroun@gmail.com; amjadmenouer@gmail.com; michel.ranari@gmail.com

IOTOOLS - Mobile Application

Computer Science and Management

Rémy MC CONNELL Mathieu VEBER Florian SMAGUE

Academic supervisor: Thomas GODEL



IOTOOLS Systems



Rémy

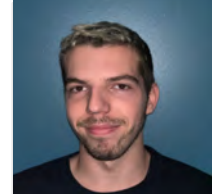

Mathieu

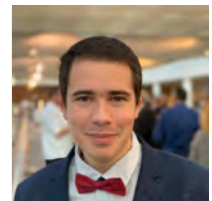

Florian

Objective/Motivation:

IOTOOLS Systems, a recent startup, has asked us to create a cross-platform, mobile-oriented solution to work with the already-existing web application: an online platform for visualizing data related to vehicles and more specifically, tires. The requirements are that the mobile solution must facilitate the client's interaction with their data as well as provide a streamlined workflow for the employees tasked with the installation of the sensors.

Results:

We have decided to split the mobile solution into two native applications, one for the clients and one for the installers, in order to deliver a better experience to both types of users. These applications were developed in React Native, which allows for the creation of both iOS and Android applications with only one codebase.

Keywords: Native Mobile Applications, React Native, IOT, sensors



The React Native, Apple, and Android logos (respectively)

Contact : remy.mc-connell@etu.umontpellier.fr ; florian.smague@etu.umontpellier.fr ; mathieu.veber@etu.umontpellier.fr

eStory

Computer Science and Management

Lucas Mas Etienne SAIMOND

Academic supervisor: Anne-Laure Villaret

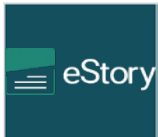

eStory

Objective/Motivation:

eStory is a web app that help users to create timeline.
Our mission was to correct some bugs on the existing application, and begin a migration of the application from PHP to React.JS

Results:

At the end of this project, we corrected many blocking bugs in the existing application, migrated existing database in a new schema, and developed React application with every features that was asked by our client (List every timelines, explore timelines by tag, search for timeline, watch a timeline, respect the original design).

Keywords: React Express Node Javascript eStory Timeline

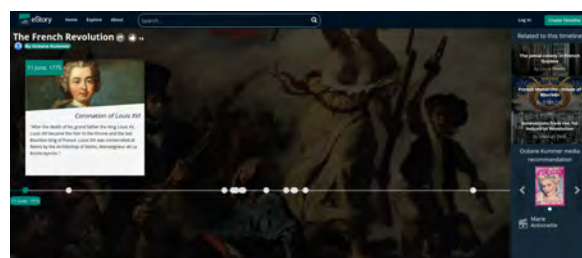

Contact : lucas.mas@etu.umontpellier.fr ; etienne.saimond@etu.umontpellier.fr

EMG-Droid

Computer Science and Management

Christophe TRANNOY

Guillaume CLEMENT

Academic supervisor:

Anne LAURENT



My Human Kit - HumanLab

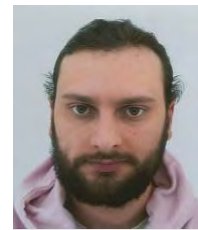

Guillaume

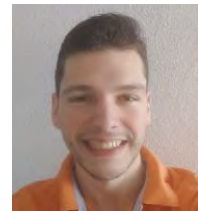

Christophe

Objective/Motivation:

Myoelectric prostheses are driven by the electrophysiological (EMG) signal, emitted when a muscle contracts. Before prescribing a prosthesis, a practitioner cannot always evaluate the EMG signal of a patient. The objective was to provide an Android application that both allows a practitioner to visualize the EMG signal and to create a "serious game" allowing patients to train to control their signal EMG.

Results:

In addition to the objectives above, the application also features a profile system that allows multiple people to have their own progress in-game, and allow the recording (and visualisation of those recordings) of the EMG signal. The signal is read via an Arduino Nano and a EMG captor, and send via a bluetooth module.

Keywords: Mobile application, Arduino, Humanlab, EMG, Medical

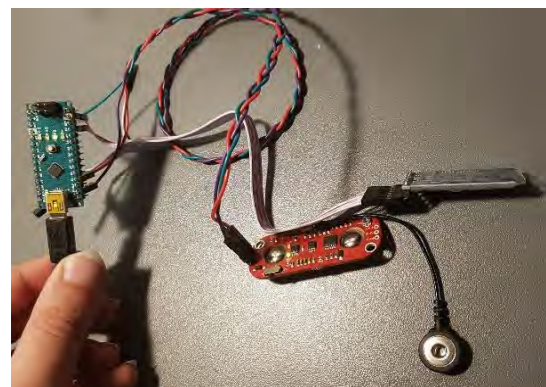
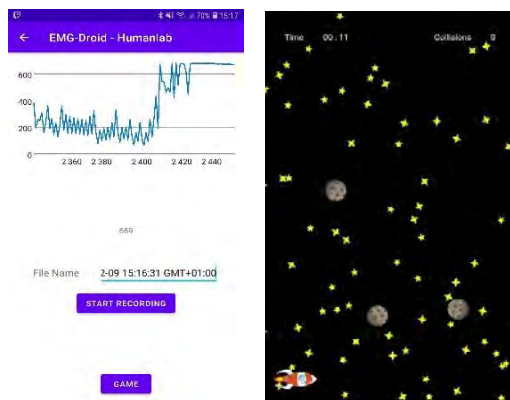

Mobile app : screenshot of Visualisation and Game, and Arduino setup used for the EMG reading

Contact : guillaume.clement@etu.umontpellier.fr; christophe.trannoy@etu.umontpellier.fr

Automated solution for deploying a Chrome session in the Cloud

Computer Science and Management

Temil Clément

Haas Matthew

Academic supervisor: Buisson-Lopez Lysiane



Company



Temil Clément



Haas Matthew

Objective/Motivation:

Waapi's products are google chrome extensions which permits to automate prospecting on LinkedIn. You can't prospect for new customers if the browser is closed. That's why one of the main features they need for their products, is to be able to start a chrome session remotely, with their extensions running.

Results:

The product we're building is a web application. On this application you can create chrome sessions with extensions and media like LinkedIn. Those sessions will be running remotely on the cloud. This product will be commercialized. We had to design it in order to be easily upgradable. We also had to make market research to propose prices for the product.

Keywords: Cloud, nodeJS, typescript , Puppeteer

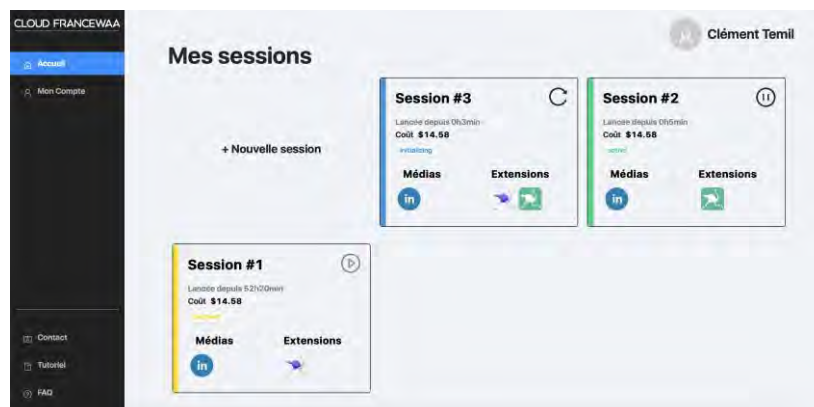

Home page of the application

Contact : clement.temil@etu.umontpellier.fr; matthew.haas@etu.umontpellier.fr

Datamining techniques to reduce PriceComparator's carbon footprint

Computer Science and Management

Adrien Alexandre Lauren Unquera

Academic supervisor: G. Toulemonde



PriceComparator

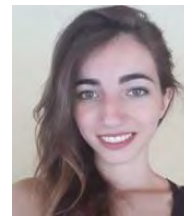

Lauren Unquera



Adrien Alexandre

Objective/Motivation:

PriceComparator is a competitive intelligence solution toward professionals. It checks each day thousands of articles their clients want to keep an eye on, but only 5% of them have their information actually updated each day. The objective is to use methods of machine learning to reduce useless internet request without missing any update.

Results:

Two methods of machine learning were selected: Logistic Regression and Random Forest. As it's essential to not miss any update of an URL, this project was focused on the sensitivity, which is the rate of true positive (cases where our algorithm predict an article to be updated and it actually gets an update in reality) . A sensitivity of 84% was obtained with the Random tree Forest method, and more than 90% with the Logistic Regression, which are even beyond our expectations.

Keywords: DDRS, URL, Machine Learning, R, Logistic Regression, Random Forest

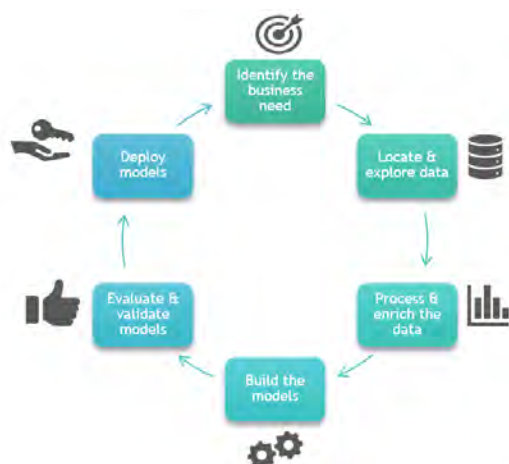

	Logistics Regression	Random Tree Forest
Recommended settings	Threshold at 0.2	100 trees and 5 attemps
Accuracy	87%	96%
Sensibility	90%	84%
Specificity	86%	98%
Optimization	Threshold ajustements (Sensibility maxed)	Hyperparameters adjustment
Execution time	< 5 minutes	< 5 minutes
Define the predictors impoertance	Yes	Yes
Prediction type	Donne la probabilité de la prédiction puis classe en fonction d'un seuil	Classe directement
Overfitting sensitivity	High	Low
RAM usage	High	High

Project process & Comparison of the two machine learning methods

Contact : lauren.unquera@yahoo.fr ; adrien.alexandre@etu.umontpellier.fr

Open Space

Computer Science and Management

Alexandra Cristina Ciubuc

Andrei-Cristi Stuparu

Thomas Cormier

Academic supervisor:

Esther Pacitti



Ippon Technologies



Alexandra



Andrei

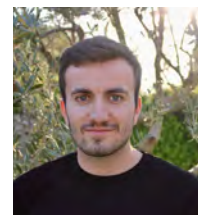

Thomas

Objective/Motivation:

In the health context of the COVID period, we set up a dashboard that allows the manager of an open space to be alerted if too many people are present in the open space, as this constitutes a health risk that we are trying to prevent.

Results:

We were able to create a dashboard, analyze video data in real time, count the number of people present in the open space, recognize from an organization chart with photographs (un trombinoscope) who is present and generate email alerts.

Github repository : <https://github.com/thomascormier/openspace>

Keywords: Dashboard, Video Analysis, Face Recognition, Deployment
Python, OpenCV, Streamlit

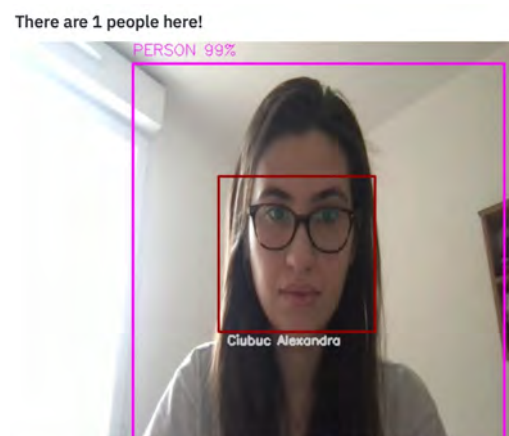
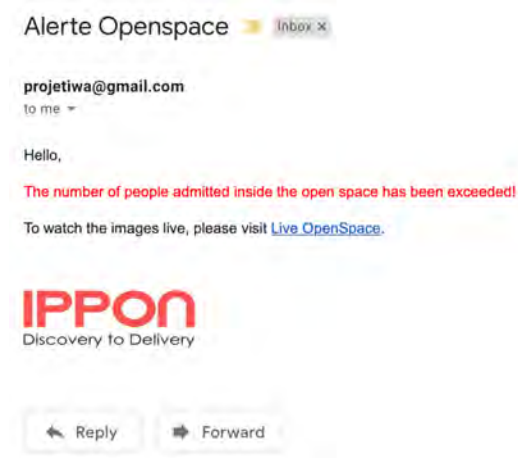

Mail alert screenshot - Dashboard screenshot

Contact : ciubucalexandra1@gmail.com ; stuparu.an@gmail.com ; thomas.cormier.00@gmail.com



Polymer hydrogels to soft robots

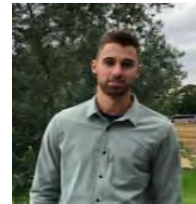

Antoine Lemonnier

Materials

Antoine Lemonnier

Academic supervisor: V.LAPINTE



Laboratory ICGM

Objective/Motivation:

The objective of this project is to develop a bilayer hydrogel based on poly (ethylene glycol) (PEG) or polyacrylamide capable of reversible deformations by sorption / desorption of water.

Results:

Each layer of the polyacrylamide bilayer hydrogel has a very different rate of swelling allowing their contrasting deformation in water. The difference in rigidity between the two layers has also been demonstrated by rheology. Finally, this hydrogel has shape memory properties allowing it to be deformed in a reversible manner according to successive hydration / dehydration cycles.

Keywords: polymer, hydrogel, soft robots, bilayer, acrylamide, shape memory

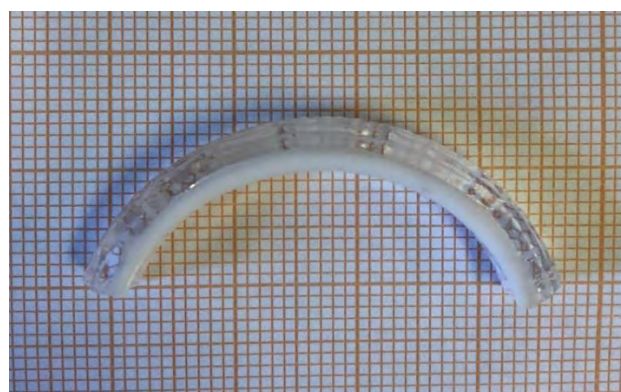
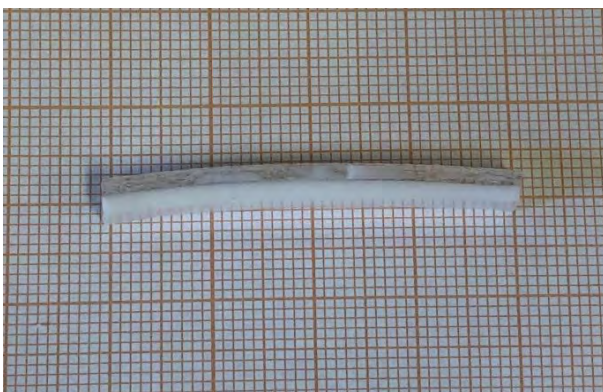

Bilayer hydrogel in its initial state and in its final state after hydration

Contact : antoinelemonnier@outlook.fr

In search of the ideal insulator



Z Villaret

Materials

Zélie VILLARET

Academic supervisors: Jean-Pierre HABAS



Academic supervisors:

Polytech Montpellier - SEG Diélectriques

Objective/Motivation:

The purpose of this project is to elaborate the "perfect" flexible laminated insulator for electrical engine. This equipment requires the definition and qualification of an insulating system based the combination of different polymers and that must fulfil the electrical, mechanical et thermal performances of concurrent products, while being more accessible from an economic point of view.

Results:

This project is still ongoing. But until now, we are not fully satisfied about the performances of the insulating system registered during industrial trials. However, we have some perspectives to improve our insulating material in particular with the introduction of different vernishes that are currently tested.

Keywords: Insulator, engine, SEG Diélectriques, electrical insulator

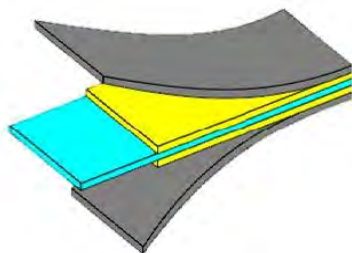

Diagram of the typical structure of laminated insulator on the left and a picture of a stator with an insulator (white part) on the right

Contact : zelievillaret@gmail.com

Glass-ceramics chalcogenides for the development of all-solid sodium



BAGLIN Samuel

Materials

Samuel BAGLIN

Academic supervisor: Andrea Piarristeguy



Polytech Montpellier/ Institut Charles Gerhardt Montpellier/axLR satt

Objective/Motivation:

The aim of the internship is to develop and characterize Na⁺ conductive sulfide glasses and glass-ceramics whose performances in terms of conductivity and electrochemical stability allow the development of all-solid batteries operating at room temperature.

Results:

The systems studied are sodium argyrodite (Na₅PS₄Cl₂) and xNa₂S-(100-x)GeSn systems by mechanosynthesis. Argyrodite is difficult to synthesize. It is unique because of the very fast crystallization kinetics, especially of the Na₃PS₄ phase. Complex impedance spectroscopy measurements were performed on 15Na₂S-85GeS₃ and 15Na₂S-85GeS₄ glasses. The results are encouraging. There are many prospects for glass-based systems xNa₂S-(100-x)GeSn.

Keywords: Glass and glass-ceramics, ion conduction, metastable phases

Contact : s.baglin@live.fr

Elaboration of porous phosphorous-based glasses by sol-gel process

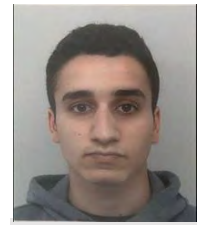

Massine Bettache

Materials

Massine BETTACHE

Hugo BERTRAND

Academic supervisors: A. Faivre, F. Despetis, A. Mehdi



Laboratoire Charles Coulomb / Institut Charles Gerhardt Montpellier



Hugo Bertrand

Objective/Motivation:

Synthesize high phosphorous glasses by sol gel process and characterize it by NMR ^{31}P , IR and XRD to identify the influence of elaboration conditions and understand reactions occurring during the synthesis.

Results:

We tried to synthesize gels of composition $45\text{P}_2\text{O}_5 - 40\text{CaO} - 15\text{Na}_2\text{O}$ under air and inert atmosphere. We obtained coloured, viscous and partially crystallized solids, instead of amorphous and transparent solids. Better results were obtained with high silica compositions, but that wasn't the goal of this project. Thanks to NMR and FTIR spectroscopy, we were able to understand that the phosphorous precursor didn't react well to form a tridimensional network.

Keywords: Bioactive glasses, sol-gel process, phosphorous glasses



High silico phosphate glass with calcium

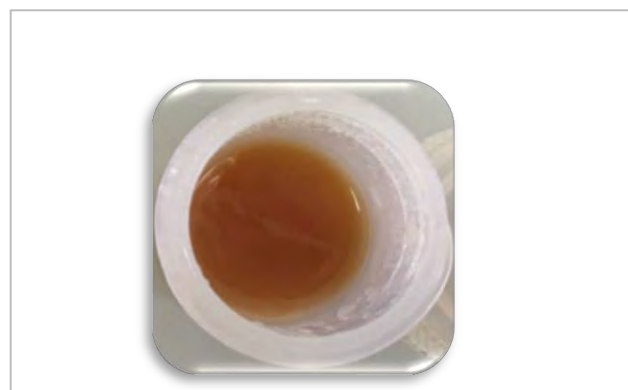

High phosphate ternary glass with calcium and sodium

Contact : hugo.bertrand@etu.umontpellier.fr ; massine.bettache@etu.umontpellier.fr

Development of biodegradable surfactants and evaluation of their interfacial properties



Alban ASSERAY

Materials

Alban Asseray

Academic supervisor: Jean-Jacques ROBIN



Institut Charles Gerhardt Montpellier

Objective/Motivation:

The purpose of this project is to prepare new surfactants which cannot be accumulated in the environment from a biodegradable polymer : poly(epsilon-caprolactone). This will involve studying the polymer synthesis reaction parameters (temperature, catalyst, reaction time, etc.) and studying the surfactant properties of the polymer to compare the CMC values obtained from those of conventional surfactants.

Results:

The results obtained are encouraging because a surfactant based on poly(epsilon-caprolactone) has been able to be synthesized and characterized. The polymerization did not pose a problem, however, it is still necessary to work on the reproducibility of the polymer functionalization experiment.

Keywords: polymer, biodegradable, surfactant, poly(epsilon-caprolactone), ring-opening polymerization.

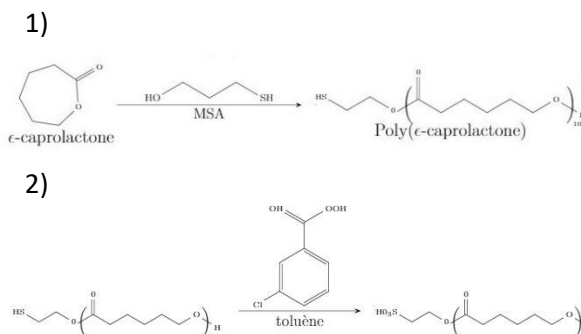

1) Polmerization of epsilon-caprolactone, 2) Functionalization of poly(epsilon-caprolactone)

Contact : alban.asseray@etu.umontpellier.fr

Formulation of a bio-based thermosetting resin for nautical use



Candice Ducastel

Materials

Morgane Pouzioux Candice Ducastel

Academic supervisor: J.-P. Habas



Yuyo / Institut Charles Gerhardt Montpellier



Morgane Pouzioux

Objective/Motivation:

The objective of this project was to formulate a bio-based thermosetting resin for nautical use that meets certain criteria such as low exothermicity, zero toxic component rejection, crosslinking at room temperature as well as a viscosity similar to the resin currently used by the company, so they don't have to change their formatting technique.

Results:

After a bibliographical review, epoxidized glycerol was chosen as biobased prepolymer and several hardeners were selected for testing. Our DSC and rheology experiments have led to a formulation that meets all of the specifications. This ideal dosage is composed of epoxidized glycerol (GE), Isophorone diamine (IPDA) and Jeffamine D-2000 in stoichiometric condition and with a molar dosage of 1.33: 0.9: 0.1.

Keywords: Bio-based, hardener, thermosetting resin, DDRS

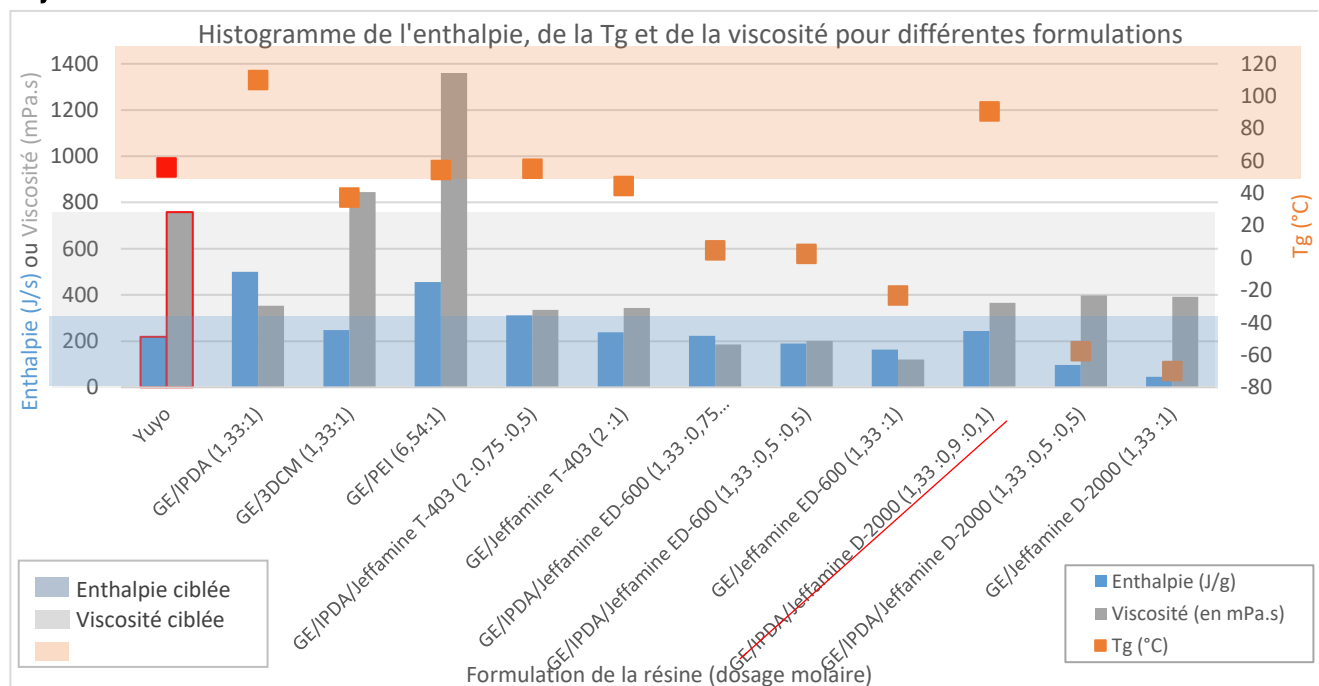

Contact : candice.ducastel@etu.umontpellier.fr, morgane.pouzioux@etu.umontpellier.fr

Elaboration of phantom samples for magnetic resonance elastography



Emile Berger

Materials

E. Berger / C. Tisserant



Célestin Tisserant



Academic supervisor: Bertrand Wattrisse

Polytech Montpellier / LMGC

Objective/Motivation:

The objective of this project is to develop "phantom" materials, whose mechanical properties are close to those of human soft tissues. These phantoms will initially be homogeneous, then include an inclusion whose mechanical properties, dimensions and position are known. Then, they will be apply to cyclic stresses to determine rigidity distributions by analysis of displacement fields .

Results:

The elasticity modulus of the phantom is relatively close to those of soft tissues or human organs. Its composition can be adjusted by gradually increasing the ratio crosslinker/catalyst to lower this module further. Its transparency and durability are very good. The inclusion of 1D phantoms is detectable by impulse elastography. Silicone seems to be a good candidate for 3D phantom.

Keywords: Elastography, Imaging, Biomechanic, Elasticity, Displacement fields



Figure 1 : Essai de traction sur éprouvette en silicone

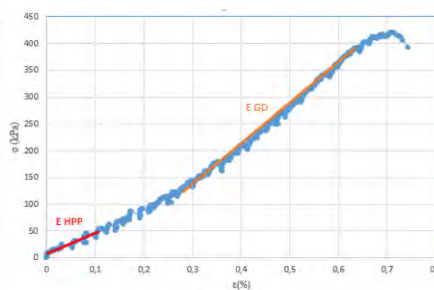

Figure 1 : Réponse en traction du silicone et illustration des modules déterminés



Figure 2 : Fantôme hétérogène 1D

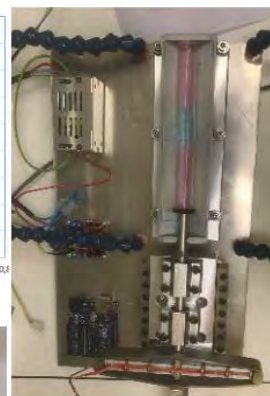

Figure 3 : Essai d'élastographie 1D

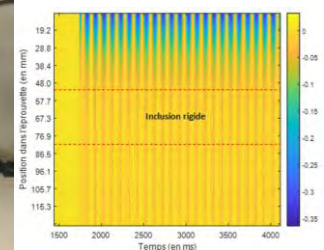

Figure 4 : Champ de déplacement dans le fantôme hétérogène

Contact : emile.berger01@gmail.com | celestisserant@gmail.com

Professional Contract - EDF



WEHMAN Ferry

Materials

WEHMAN Ferry

Academic supervisor: MURACCIOLE Jean-Michel



EDF - CNPE de Flamanville 1&2

Objective/Motivation:

During my professional contract, my main missions are the management of the corrosion case and the anchoring case. Indeed, corrosion is an essential problem in nuclear power plants and I work on the perpetuation of materials, essentially on stainless steel. Regarding anchors, the aim is to control their compliance and, if not, to drive the return to compliance of all of them.

Results:

During these two months, a large part was devoted to adapting the industrie of nuclear. Indeed, working in a big farm like EDF requires an understanding of their operation and all the tools at their disposal. Regarding the corrosion case, I am implementing different solutions for the treatment of the anomalies. The solutions are based on predictive maintenance so results will appear in the long term.

Keywords: Corrosion, Anchors, Nuclear



View of Nuclear Power Plants of Flamanville (Source : EDF Médiathèque)

Contact : ferry.wehman@hotmail.fr



Development of a new tanning method



VATINEL

Materials

Florian VATINEL



Louka DE TOURNEBU

Academic supervisors:

Ahmad MEHDI



Louka DE
TOURNEBU

Institution / Company / Laboratory

Introduction/Objective:

Leather tanning has been carried out for generations using chromium oxide which results in quality leather with good properties. However, the use of chromium oxide is increasingly criticized for being the cause of certain allergies and is possibly carcinogenic. Thus, the study of this project focuses on the development of a new way of tanning method using the sol-gel process to obtain properties similar to leather tanned with chrome.

Results:

The tanning of the leather was done using silica precursors (TEOS, APTES) in acid solution and stirring for a certain time. Once the leather samples were tanned and dried in an oven (40 ° C), they were studied and analyzed using characterization techniques such as SEM / EDX, microscopy, shore durometer, traction, etc. Based on these analyzes, we were able to conclude that the samples exhibited properties that were relatively different from those of chrome tanned leather.

Keywords: Leather, tanning, DDRS, silica, gel sol

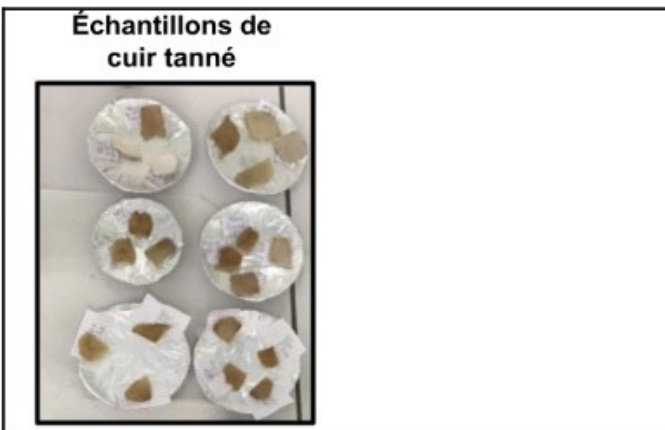

Biological and Food Engineering
Computer Science and Management
Materials
Mechanical Engineering and Interactive Design
Microelectronics and Automation
Water Science and Engineering
Select

Photo caption

refractory materials based on natural clay



Materials

Kenneth DASSI

Academic supervisors: Philippe Papet



Polytech Montpellier- University of Montpellier

Objective/Motivation:

This project aims to formulate and study refractory materials based on clay and pozzolana from the Comoros archipelago. These ceramics will be placed as refractory materials in ovens dedicated to the distillation of plant for cosmetic applications.

We will therefore determine if these ceramics will be viable and durable for their application by performing biaxial bending and thermal shock characterizations.

Results:

An X-ray fluorescence study made it possible to determine the main components of clay and pozzolan which are mainly oxides (SiO_2 , Al_2O_3 , Fe_2O_3). We then measured an open porosity of 15% for sintered ceramics containing 80% clay and 20% pozzolan. Finally, the bi-axial bending allowed us to measure the mechanical strength of these ceramics, which is 35 MPa. The mechanical strength of the formulated refractory ceramics is not too much degraded even after thermal shocks up to 600 °C.

Keywords: refractory materials, clay, pozzolan, X-ray fluorescence, bi-axial bending, porosity, thermal shock

Contact : kenneth-senan-camero.dassi@etu.umontpellier.fr
phillipe.papet@umontpellier.fr

Oxo and alkoxo metalphosphonates for the preparation of metal oxide-based hybrid materials



Oriane Maurin

Materials

Martin Veyrune Oriane Maurin

Academic supervisor: G. Guerrero

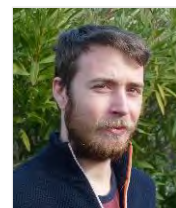

Martin Veyrune



Polytech Montpellier / Institut Charles Gerhardt Montpellier

Objective/Motivation:

The objective of this project was to prepare different oxo alkoxometalphosphonate clusters as precursors of hybrid materials by a two step sol-gel process based on metal alkoxides and phosphonic acids. Different parameters were studied such as the nature of the organic group of the phosphonic acid, the use of a mixture of different phosphonic, metal alkoxides with different organic groups or different metals. Finally, hybrid materials were prepared taking account of these parameters and analyzed.

Results:

Main clusters were synthesized from various metal alkoxides and phosphonic acids. The kinetic of the cluster reaction formation depends on the alkoxide type. When acids are mixed together, clusters seem to contain both acids. Synthesized hybrid materials were amorphous and homogenous chemically.

Keywords: hybrid material, coupling agent, phosphonate, cluster, building blocks



Hybrid materials: xerogel (left) and gel (right)

Contact : veyrunemartin@gmail ; oriane.maurin@gmail.com

Study of the microstructure of fused cast ceramic materials



Pierre-François Motte

Materials

Pierre Quemeneur

Pierre-François Motte

Academic supervisor:

Nicole Fréty



Pierre Quemeneur

Objective/Motivation:

The aim of this project is to study the microstructure of HZFC (High Zirconia Fused Cast) ceramics using SEM (Scanning electron microscopy) observations coupled with EDS (Electron Dispersive Spectrometry) and EBSD (Electron Back-Scattered Diffraction) analyses.

Results:

EDS and EBSD analyses show that HZFC ceramics are made of monoclinic zirconia grains embedded in a glassy phase. Micro-indentation tests were further performed to determine the microhardness of these phases.

Keywords: ceramics, HZFC, SEM, EDS, EBSD, micro-indentation

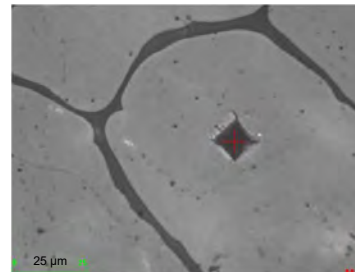
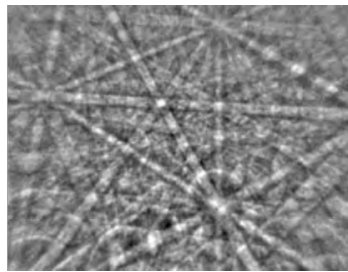
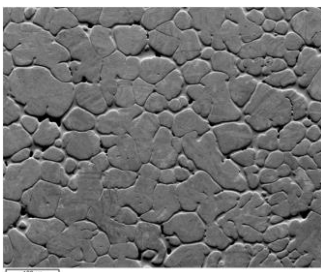

HZFC characterisation: SEM image, zirconia EBSD diagram and micro-indentation test

Contact : pierre_f.motte@yahoo.fr ; pierre.quemeneur@etu.umontpellier.fr

Photothermal properties of carbon nanotubes/polymer microgels



MAURY G.

Materials

Bastien FERRIER

Guillaume Maury

Academic supervisor:

Eric Anglaret



Laboratory Charles Coulomb



FERRIER B.

Objective/Motivation:

Study of the optical properties (photoluminescence, absorbance) for two kinds of samples : aqueous dispersions of Single Walled Carbon NanoTubes (SWNT) with surfactant and composites SWNT/polymer matrix. Impact of various experimental parameters (such as temperature of the dispersion, power and wavelength of the exciting source) are investigated thanks to UV-Vis-NIR Spectroscopy and Raman Spectroscopy.

Results:

Most suitable parameters to achieve optimal optical measurements have been determined. This allowed us to show that the photoluminescence energy of SWNT dispersions (in water or in polymer matrix) depends on temperature (see figures below), which is a promising property for example in the realization of thermal sensors.

Keywords: Raman & Absorption spectroscopy / Carbon nanotubes / SDS / PNIPAM

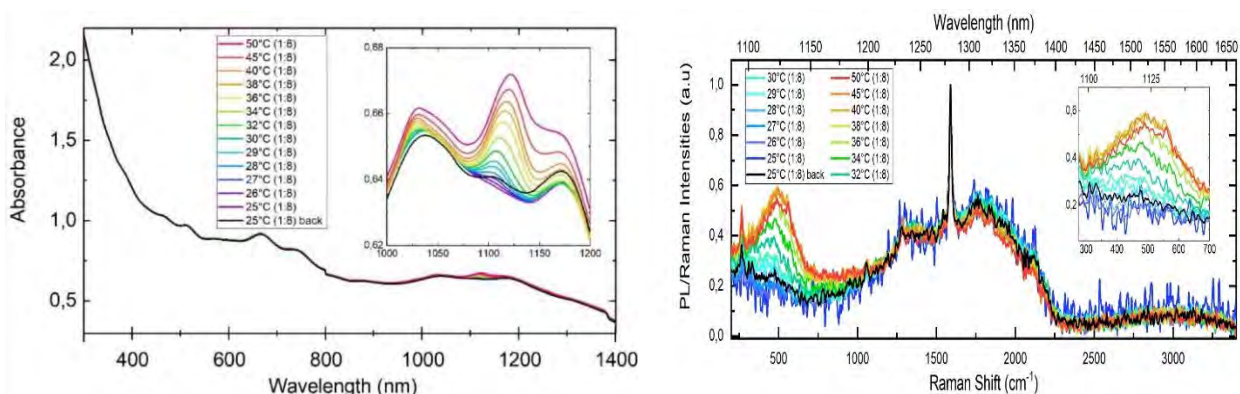

UV-Vis-NIR spectra (left) and PL/Raman spectra (right) of a SWNT dispersion depending on the temperature. Changes are clearly visible in the area around 1125 nm.

Contact : guillaume.maury01@etu.umontpellier.fr ; bastien.ferrier@etu.umontpellier.fr

Water aging studies of polyurethane



PAGIS Lucile

Materials

Lucile PAGIS

Academic supervisor: V. LAPINTE



Groupe COURBIS

Objective/Motivation:

A significant part of the contracts carried out by the group are concluded with the offshore market. Therefore COURBIS wants to know polyurethane behaviour when it is submerged in water for a long time.

Results:

A decrease of the tensile strength and an increase of the elongation at break are observed. These variations are caused by physical aging (plasticization) and chemical aging (hydrolysis).

Keywords: Polyurethane, water aging, mechanical properties, tensile test, hydrolysis, plasticization.



Example of polyurethane pieces for the offshore market: optical fiber protections.

Contact : lucilepagis@gmail.com

Professionalization Contract : Structural design office



Clément MIRABEL

Materials

Clément MIRABEL

Academic supervisor: Jean-Michel MURACCIOLE



Idéum Partners

Objective/Motivation:

Structural calculation in the field of private building but also in civil engineering. Structure diagnosis and risk prevention.

Results:

Calculation of structures , Formwork plan , Reinforcement plan , Diagnostic report.

Keywords:

Building, Calculations, Structure, Reinforced Concrete, Building Material.

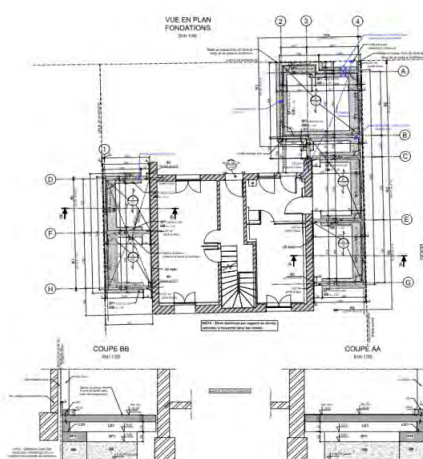

1° Sizing of load-bearing elements



2° Example of pathologies found in buildings

Contact : clement.mirabel@etu.umontpellier.fr

Cement/Carbon nanoparticle composite

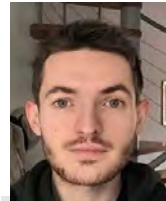

MOLES Rémi

Materials

MOLES Rémi

Academic supervisors: Aikaterini Ioannidou,
Bertrand Wattrisse,
Philippe Papet

Laboratoire de Mécanique et Génie Civil (LMGC), Montpellier

Objective/Motivation:

Study the impact of the composition and damage of cement/carbon nanoparticle composite on mechanical, electrical and thermal properties. Three water/cement ratios will be used (0.42, 0.6, 0.8) For each of them we will vary the carbon rate (from 0 to 7% by mass). We have studied 22 compositions. These measurements have been done: -complex impedance spectroscopy (before and after damage). - rupture compression test. -Joule effect (before damage).

Results:

rupture compression test: mechanical strength decrease when water/cement ratio increase. The carbon rate don't have any impact on the young modulus. Complex impedance spectroscopy: conductivity increase when carbon rate. The water/cement ratio don't have a big impact on the conductivity. The damage of the sample increase the conductivity because of plastic deformation during the compression (10% of the mechanical resistance). Joule effect: the joule effect increase a lot when the carbon rate increase.

Keywords: Cement, carbon nanoparticle, compression test, Joule effect, complex impedance spectroscopy, DDRS, supercapacitor.

Contact : Remimoles.pro@hotmail.com

Initiation and detection of micro-cracks in silica glass



Ana Carolina

Materials

Ana Carolina S Frantz

Academic supervisor: Annelise Faivre



Charles Coulomb Laboratory and Safran Electronics & Defense

Objective/Motivation:

This project was carried out to understand the consequences of machining and acidification on silica glass surface and subsurface. These manufacturing steps are directed related to the surface stabilization and, by consequence, on performance. Since we desire to understand their side effects, several variables have been observed, and three studies promoted through this project. The first study was focused on the crevices, Figure 1(left), while the second one on heat treatments, and the third one on the "step" formed when cleaving silica bars, Figure 1(right).

Results:

Through the first study, which focused on crevices, we managed to fabricate them artificially. It is early to say that the structures we found are precisely the same; however, they are approaching those original defects. We can conclude such improvements as an excellent result because, from now on, crevices can be manipulated on flat surfaces. Besides, it has been found that the different surface treatments can impact the average size of those defects. Our second study focused on heat treatments and their impact on silica glass surfaces submitted to hydrofluoric acid. After observations and comparisons between samples, before and after heat treatments, no significant effect was observed. A negligible growth rate was found for all samples treated at 800°C, 1000°C, and 1200°C. The last and third study was focused on the "step" formed on silica glass. Actually, this behavior was noticed firstly by Mme Lena Chenais. In this study, we were interested in understanding under which circumstances the "step" could be formed. It has been found that the nature of the glass and the surface treatments have an impact on the size of the step formed.

Keywords: SSD, micro-cracks, acidification

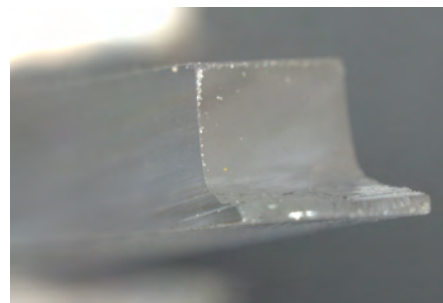
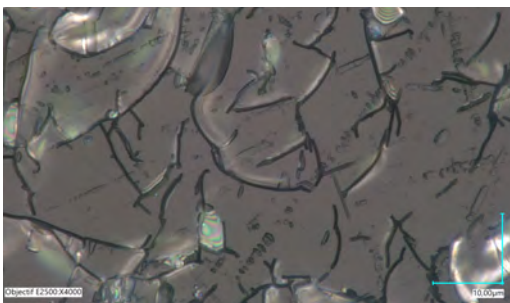

Figure 1: (Left) Crevices revealed on silica after an acid bath. (Right) The "step" on silica, the phenomenon founded by Lena Chenais

Contact : ana-carolina.schuh-frantz@etu.umontpellier.fr

Use of FTIR-ATR for the quantitative analysis of free fatty acids in oenology



Clémence VUILLET

Materials

Clémence VUILLET

Academic supervisor: Jean-Louis BANTIGNIES



Plateforme IR-Raman du Laboratoire Charles Coulomb, NYSEOS

Objective/Motivation:

The quality analysis of musts is an efficient way to ensure the revelation of aromas during fermentation and therefore an important issue for research in the oenology sector. NYSEOS is developing a diagnostic tool that quantify molecules of interest while guaranteeing rapid results and high repeatability. The use of IR-ATR spectroscopy is hereby reviewed.

Results:

The observation of the IR spectra of samples enriched with palmitic acid confirmed the suitability of the ATR technique for the quantification of FFA in the samples. Indeed a linear relation was found between the concentration in acid palmitic and the observed areas of its characteristic peaks. The use of IR-ATR spectroscopy seems to be suitable for the quantification of this flavour precursor.

Keywords: IR Spectroscopy, Quantitative analysis, Oenology, Curve Fitting, Aroma Analysis.

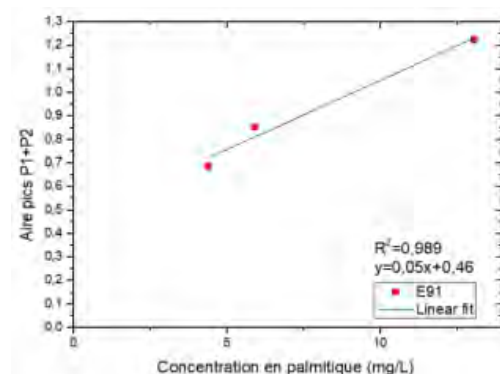

Figure 1 : Plotting of the areas of the peaks as a function of the corresponding LFA concentrations

Contact : clemence.vuillet@etu.umontpellier.fr

Synthesis of Phase Change Materials



João Gustavo
MALLMANN

Materials

João Gustavo Mallmann

Academic supervisor: Gilles SILLY



Institut Charles Gerhardt de Montpellier

Objective/Motivation:

The materials studied in this synthesis are the two extremities of pseudo-binary of an important group of phase change materials. They are also the main candidates for a use for data storage as a material for the Phase Change Random Access Memory (PCRAM). The collection of data is done through the transition of these materials from the amorphous to crystalline phase and vice-versa. Here, we focused on the synthesis of the GeTe via a liquid route using much lower temperatures than those used in an oven (180 °C for the liquid synthesis compared to 850 °C for the oven synthesis). This will bring a considerable energy gain, and therefore, a more sustainable alternative. Here, we want to synthesize a single crystal of Sb₂Te₃ in order to simplify the analysis and better understand the structure of the material.

Results:

The GeTe's synthesis was not concluded with a good result cause we could not recover the powder at the end of the reaction. After all, it remained in the filter paper. Also, the color of it was blacker than expected. It is important to reiterate that this is the first time we have tried to use this synthetic route. Besides, we made some approximations during the synthesis, and suggestions were proposed in the report. These will help for future work.

The single-crystal synthesis was done using the Bridgman growth technique. We have observed the formation of a crystal after the synthesis. It was analyzed through Laue diffraction to identify its crystallinity, single or polycrystal, and X-Ray diffraction to determine the phases produced during the synthesis. Apart from the crystal, a small part of the mixture didn't react and possibly referred to the antimony. We could also observe that the tube's walls have gone darker, probably related to the high tellurium vapor pressure. The analyses confirmed both the formation of a single crystal, at least in the analyzed part, and the appearance of one single-phase, the antimony telluride (Sb₂Te₃). The analyses were made just in the crystal. The exceeding part wasn't analyzed because of the low quantity.

Keywords: PCM, synthesis, GST

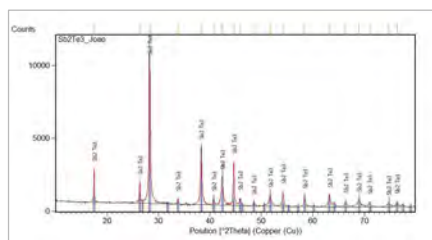

Figure 1: (Left) Diffractogram of the antimony Telluride. La phase Sb₂Te₃ corresponds to all peaks. (Right) Crystal produced after a full Brdgmán growth

Contact : joao-gustavo.mallmann@etu.umontpellier.fr

Quantification of the environmental impact of the manufacturing process of a ceramic material

Materials



Khadija Hajjaj

Robin Sales

Khadija Hajjaj

Academic supervisors:

J-L Bantignies / P. Papet



Polytech Montpellier / Saint Gobain



Robin Sales

Objective/Motivation:

This study was conducted based on the goal of Saint Gobain Research Provence to improve the carbon footprint caused by the manufacturing of their ceramic products. In our case, we focus on the elaboration of AZS grinding beads. A life cycle assessment was done to determine the current CO₂ emissions aiming at proposing solutions and ways to lower them.

Results:

The results of the analysis gave us an idea on the carbon dioxide emissions of the grinding beads and allowed us to suggest solutions and procedures that could be followed to decrease the environmental impact of the beads elaboration.

Keywords: LCA, ceramics, grinding beads, carbon footprint, DRS

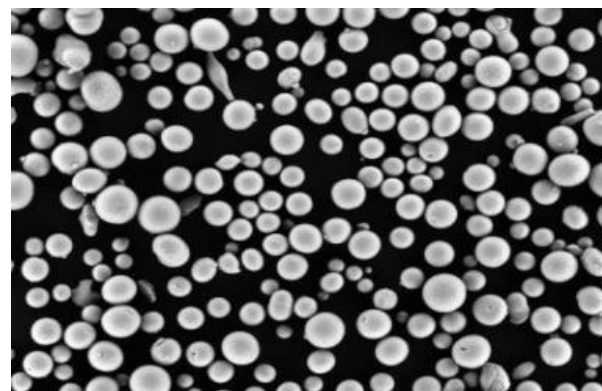
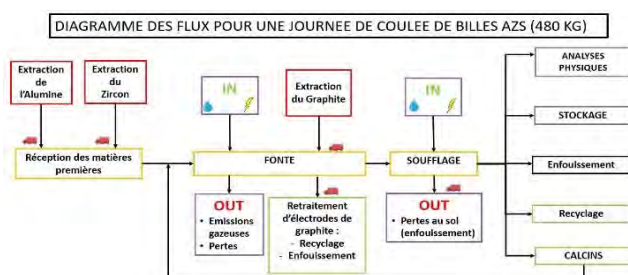

Left : Grinding beads flow diagram. Right : microscopic view AZS grinding beads

Contact : khadija.hajjaj.98@gmail.com ; robin.sales10@gmail.com

POSS, polyhedral oligomeric silsesquioxanes : silica nanocages as building bricks of functional materials



Paul MICHEL

Materials

Paul MICHEL



Academic supervisors: LE PARC / BANTIGNIES /
WONG CHI MAN

ICGM / L2C

Objective/Motivation:

The main goal of this project was to synthesize cubic POSS Vinyl₈T₈ (also called OV-POSS for octavinylPOSS). The long term objective is to characterize composites POSS-polymers under high pressures.

Results:

We successfully synthesized Vinyl₈T₈F⁻, a POSS with a fluoride ion located inside the cage. The different characterization techniques used to confirm this synthesis were H NMR, FTIR and Raman spectroscopy.

Keywords: POSS, Vinyl₈T₈F⁻, Vinyl₈T₈

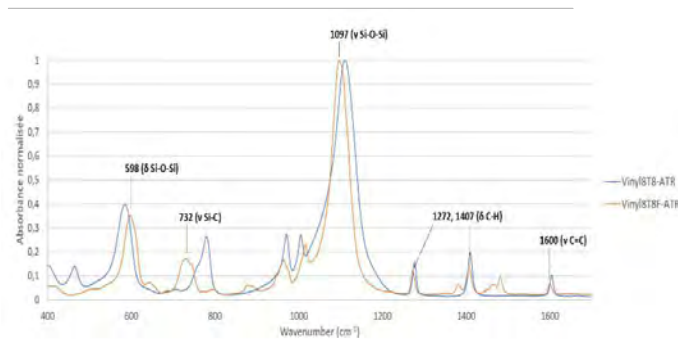

left : FTIR spectrum of Vinyl₈T₈F⁻ and Vinyl₈T₈ ; right : crystals of Vinyl₈T₈F⁻ after filtration (left) and in solution (right)

Contact : paul.michel01@etu.umontpellier.fr

Optimisation of a levitation device of superconductor on magnetic circuit

Materials

Théo DESFONTAINES Cyriaque MAS

Academic supervisors: Vincent JOURDAIN
Gilles GUERRERO



Institution Polytech Montpellier / Laboratory Charles Coulomb
and Institute Charles Gerhardt Montpellier

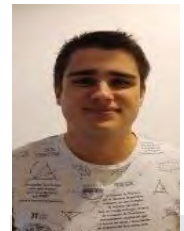

DESFONTAINES
Théo



MAS Cyriaque

Objective/Motivation:

The first goal of the project is to develop superconducting levitators with improved properties (repulsion force, levitation time, ...) compared to the commercial ones and to create levitators with complex shapes by using polymer moulds obtained by 3D printing. The second goal of the project is to make a video of quantum levitation for the communication of the materials department.

Results:

Creation of high temperature superconducting ceramics using the sol-gel process. Tests of PLA printed nitrogen tanks to improve the levitation time. Moreover, tests of insulation of superconducting ceramics with polymer foams that leads to increased levitation times. Realisation of the video.

Keywords: Superconductor, Magnets, Quantum Levitation, 3D printer, Video

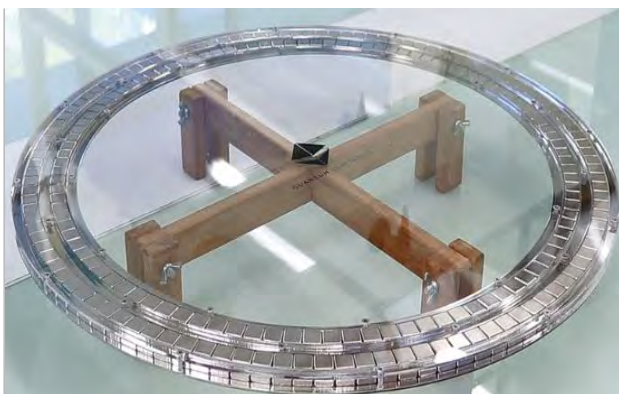

Contact : desfontaines.theo@orange.fr ; cyriaque_mas@hotmail.fr

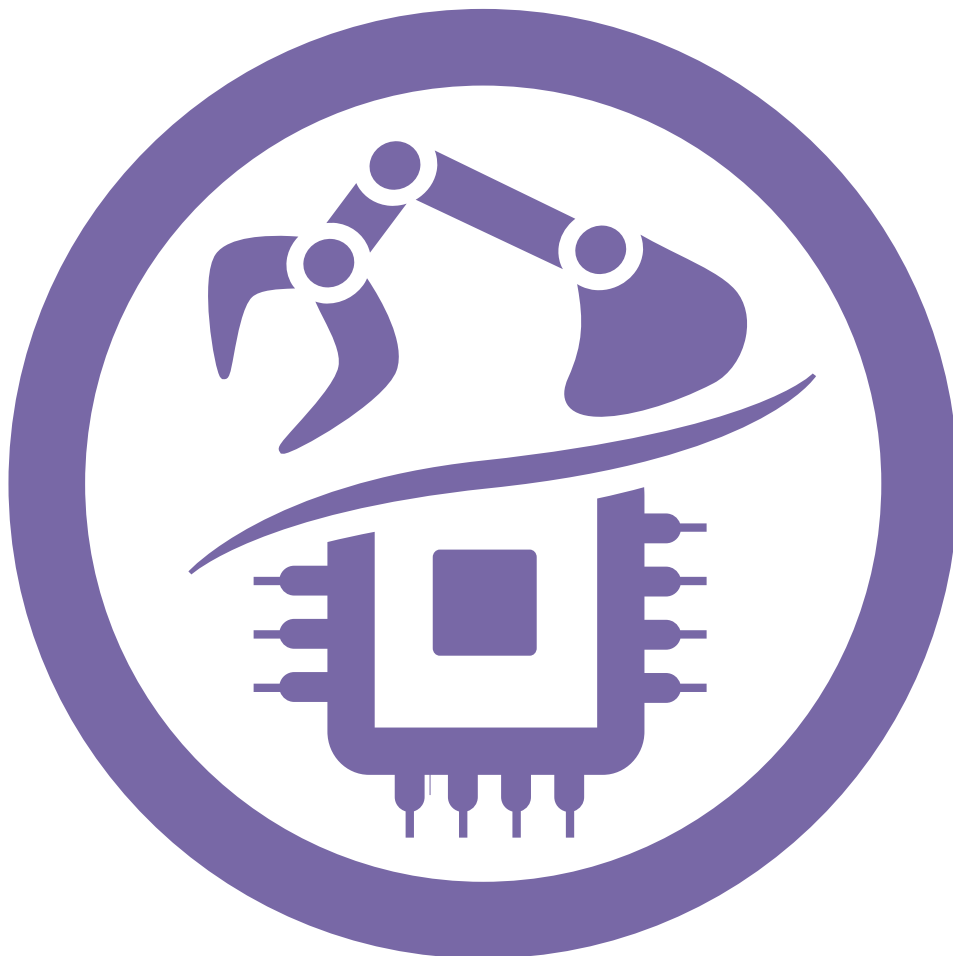

Mise en oeuvre d'algorithmes de réduction de réseaux de Pétri temporels



Microelectronics and Automation

Arthur Morel

Academic supervisor: David ANDREU



NEURINNOV

Objective/Motivation:

The startup NEURINNOV, designs and develops devices for implantable medical devices (DMIA). In order to formally model complex and critical digital systems, the Start up has developed the HILECOP software. The latter translates the embedded intelligence of the DMIA into an analyzable language and then generates code that can be implemented on FPGAs (reprogrammable integrated circuits) or synthesized on ASICs.

The goal of the project is to implement some algorithms for the temporal reduction of Petri nets to reduce the model while preserving its properties.

Results:

Currently all the reductions of Boussin are possible, as well as the export of the residual file under XML. Indeed, after applying the Boussin reductions, my computer structure only contains the post-reduction residual model, so we retranslate this model in PNML to be able to inject it in the TINA analyzer. In the end, only the temporal and timed reduction algorithms could not be implemented.

Keywords: Temporal Petri nets, Reduction algorithms, Complex and critical digital system, Qt Creator, C/C++, PNML.

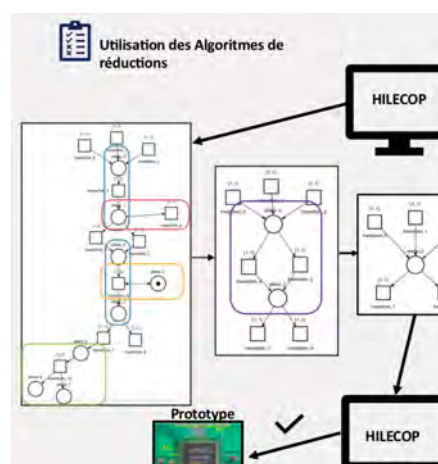
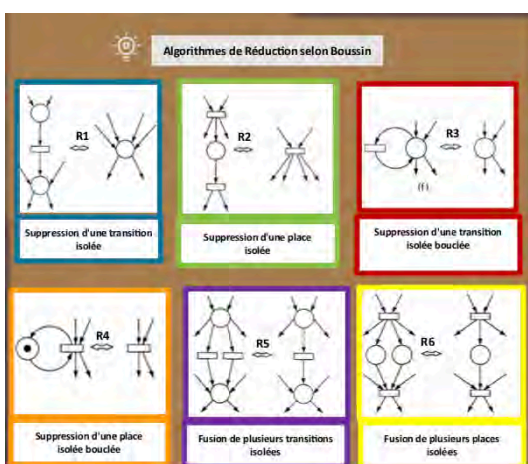

Contact : arthur.morel01@etu.umontpellier.fr

Cache Calibration for Accurate Simulation of Multi-core Systems



MARTINS BASSO
Pedro

Microelectronics and Automation

MARTINS BASSO Pedro

Academic supervisor:

NOVO David



Objective/Motivation:

This project aims to model the ARM Neoverse N1 architecture using the gem5 simulator. This work propose methods to modelize the architectre in the simulator. Also, we propose a cache-level acces time calibration procedure using microbenchmarks. We use real hardware that implements the Neoverse N1 architecture to calibrate our Neoverse N1 model.

Results:

The results of the work show that our calibration method reaches cache delay access time accuracy closes to the real hardware.

Keywords: Computer Architecture, Computer System Simulation, Memory Hierarchy

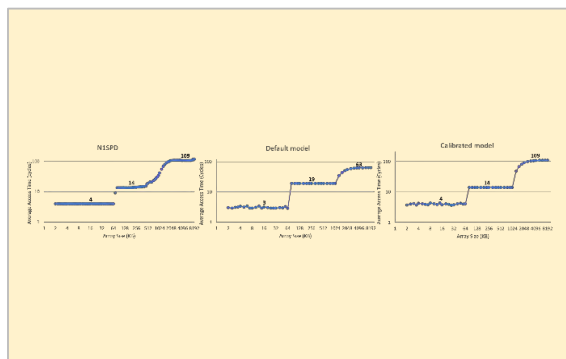

gem5 Cache module	gem5 cache Parameter	Default	Calibrated
L1_ICache	size	32 KB	64 KB
	replacement_policy	LRURP	LRURP
	writback_clean	false	true
	associativity	2	4
L1_DCache	size	32 KB	64 KB
	replacement_policy	LRURP	LRURP
	writback_clean	false	true
	associativity	2	4
L2_Cache	size	1MB	1MB
	associativity	16	8
L4_Cache	size	N/A	1MB

gem5 Cache module	gem5 cache Parameter	Default	Calibrated
L1_DCache	tag_latency	2	3
	data_latency	2	3
	response_latency	2	3
L2_Cache	tag_latency	12	5
	data_latency	12	5
	response_latency	12	5
L4_Cache	tag_latency	30	89
	data_latency	30	89
	response_latency	30	89

Achieved results using our methodology

Contact : pedro.martins-basso@etu.umontpellier.fr

Secure deployment of a network of connected objects

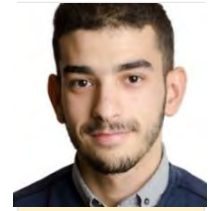

Hamza AGHARBEN

Microelectronics and Automation

Hamza AGHARBEN

Academic supervisor: L. TORRES



Algodone

Objective/Motivation:

Algodone offers a patented product, SALT (Silicon Activation Licensing Technology) allowing to control and measure the activities of a system in a secure way. Algodone proposes turnkey solutions to implement secure communication links with connected objects (IoT). The SALT technology is the cornerstone of the solutions deployed by Algodone. The solutions allow precise monitoring of time of usage of objects or functions inside objects. Monetization of hardware as a service becomes possible. The aim of the project is to demonstrate that it is simple and efficient to deploy Algodone products, especially SALT product in a complete IoT- type system.

Results:

In order to secure IoT device, a full environment has been developed based on a FPGA board, a Raspberry PI and a Software SaaS managing devices license. The overall framework allows to emulate a full deployment of IoT chain from the cloud server (SaaS (can be seen as remote software)) to an IoT board (FPGA), with the support of a gateway (Raspberry PI).

Licenses created by SaaS are encrypted using the FPGA cipher key (FPGA encrypted ID) and an activation code which is a code associated with each functionality that is wished to control. The Licenses can only be decrypted by the SALT API of the FPGA that made the request to SaaS, it result on a system that is quite robust against malicious attack.

Once the license has been received, all that remains is to decrypt it in order to retrieve the activation code and enable the associated functionality, now you know how to safely enable a functionality think to SALT solution.

Keywords: ARM processor, Raspberry Pi, IoT, Atollic, BLE, RSA, C

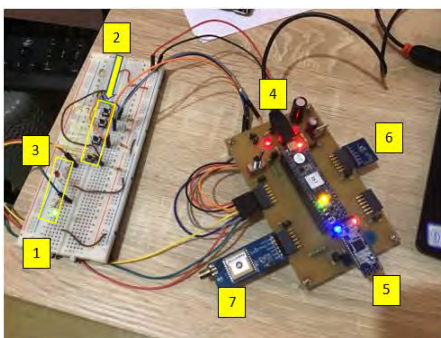

- 1) Breadboard
- 2) Push button
- 3) Red and green LED
- 4) FPGA
- 5) BLE module
- 6) Light sensor
- 7) GPS module

```

Please push a button to enable a sensor... 1
Sending the AC : f034fd4c81f6c738a0c95c7d1f23a543 ... 2
Activation Code sent
Waiting for the Activation Code from the CRM ... 3
Activation Code received !!
Activation Code is: f034fd4c81f6c738a0c95c7d1f23a543
It's the LUMINOSITY Activation Code.
The board enable the luminosity sensor
luminosity : 18 4
Please push a button to enable a sensor...
  
```

- 1) First, the user is invited to press a button to activate a feature
- 2) Then, he is informed that the FPGA has successfully transmitted the Activation Code associated with its functionality
- 3) Subsequently, the FPGA informs the user once he receives the Activation Code resulting from the decryption of the License.
- 4) Finally, the user can see that the feature he has decided to activate is indeed active.

Contact : hamza.agharben@etu.umontpellier.fr

Evaluation de solutions électroniques pour la récupération d'énergie



David Jiménez
Caballero

Microelectronics and Automation

David Jiménez



POLITÉCNICA

UNIVERSITÉ MONTPELLIER / POLYTECH / MEA

Academic supervisors:

Laurent Latorre /
Pablo García-Linares

Objective/Motivation:

The objective of the project is to be able to develop a PCB that allows to harvest energy from the environment and use it to charge batteries.

Results:

Two PCBs, the main one that harvests and sends the information via RF module and the receptor one that catches that information and delivers to a computer.

Keywords: Embedded Systems, Energy Management, Photovoltaic, Battery, PCB, RF.

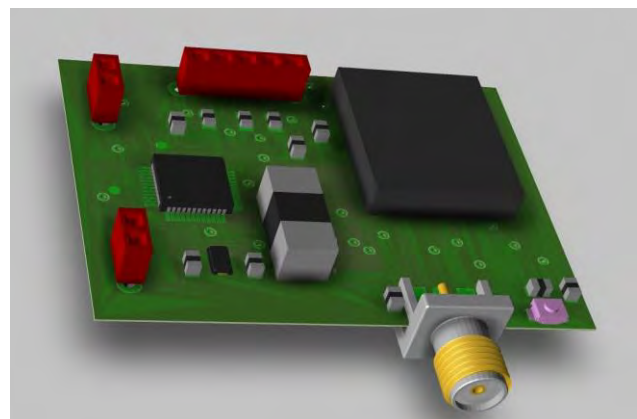
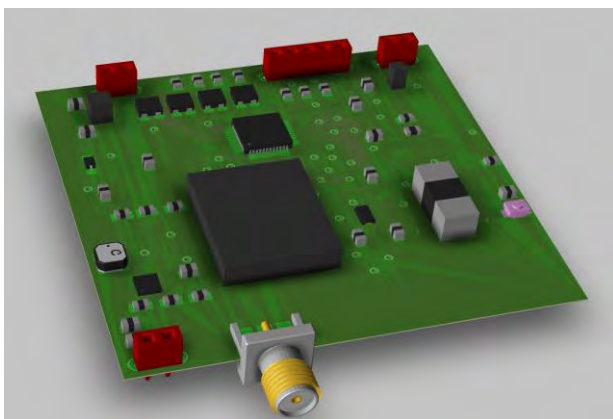

PCB Allegro Editor , Friday 29th January 2021

Contact : david.jimenez-caballero@etu.umontpellier.fr

Autonomous environmental sensor

Microelectronics and Automation



Gauthier Chabrolin



Academic supervisor: F. Soulier

MARine Biodiversity, Exploitation and Conservation (MARBEC)

Objective/Motivation:

Designing an autonomous environmental sensor to measure pH, temperature and water-level of the lagoons at the South of Montpellier (France). PH sensing must use an Ion Sensitive Field Effect Transistor (ISFET) provided by the Laboratory of Analysis and Architecture of Systems (LAAS).

Results:

A prototype based on a STM32L4 microcontroller has been developed. It is supplied by solar panels and communicates data via LoRa protocol. It has proved able to measure pH and correct data with temperature calibration.

Keywords: Autonomous sensor ; pH ; LoRa ; STM32 ; DFSDM ; ISFET

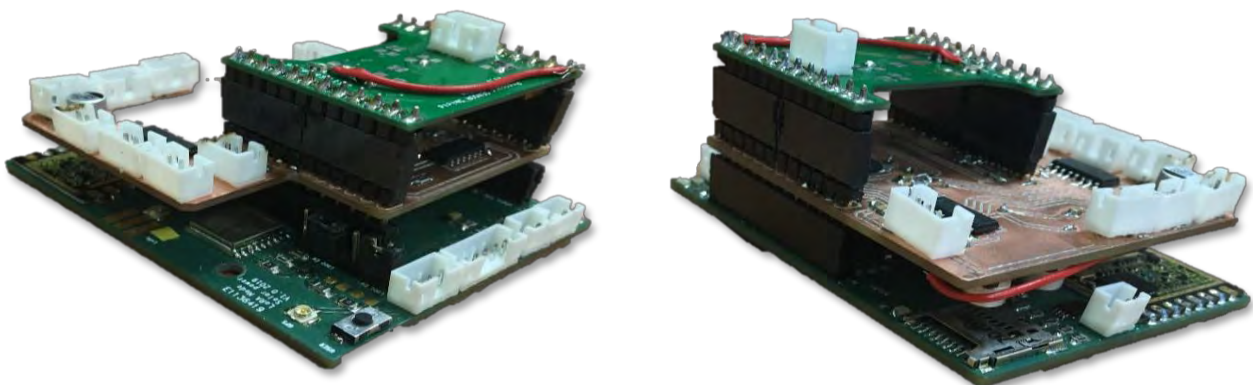

Printed circuit boards for measurements and data computing

Contact : gauthierchab@hotmail.fr

ELECTROMAGNETIC AUTHENTICATION

Microelectronics and Automation

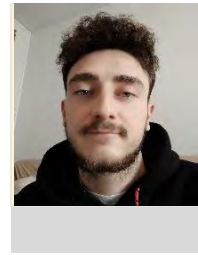

Guillaume Rouse

Academic supervisors:

Philippe Maurine

LIRMM Laboratory

Objective/Motivation:

This project consists in developing a product which can measure the magnetic susceptibility of an human finger in order to extract an exploitable biometric fingerprint. I chose this project because it is a research project with human aspect and the final goals it's to prove something works.

Results:

The results prove that the magnetic susceptibility of a human finger can be used to extract a biometric fingerprint. Because we can measure the difference of the magnetic field with and without finger. However, extracting a biometric fingerprint is complicated task and the developed prototype must be enhanced to further emphasize the existing differences between people.

Keywords: Magnetic field, biometric fingerprint

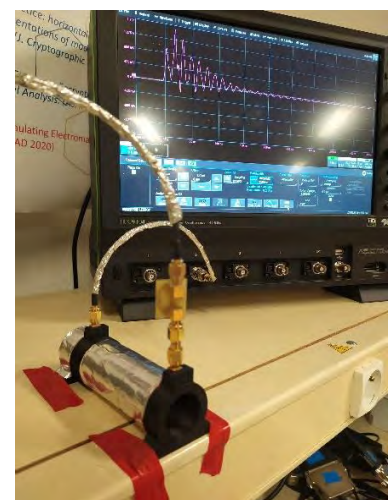
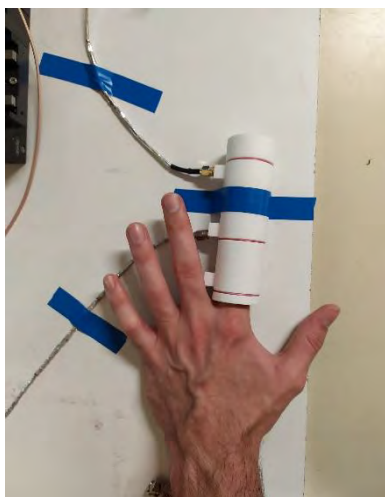

Contact : guillaume.rousse.pro@gmail.com

Connected shelves

Microelectronics and Automation

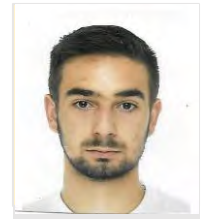

Jeremy BERTRAND

Jérémy BERTRAND

Academic supervisors: E. Dubreuil / A. Vena



IES Engineering

Objective/Motivation:

Realization of connected shelves for the HUMAN at home project. Using RFID antennas and weight sensors, we are able to read RFID tags and measure the weight of each product and then warn the user to take care of this information. The objective is to optimize this existing project for an apartment implementation.

<http://www.hut-occitanie.eu/wp-content/uploads/2019/05/Dossier-de-Presse-HUT.pdf>

Results:

I2C communication, between the shelves and a LoRa module to send data into a network, was made. The improvement of the entire data processing chain has been achieved. The shelves are operational for use in the connected apartment.

Keywords: RFID, SPI, STM32, I2C, LoRA

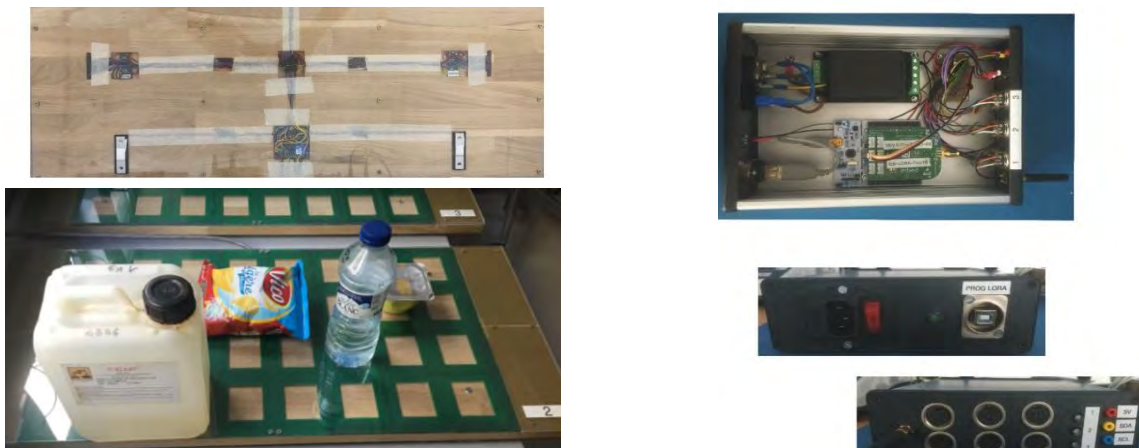

Shelves with antennas - LoRa module

Contact : jeremy.bertrand@etu.umontpellier.fr

RFID Localisation



Lefèvre

Microelectronics and Automation

Hugo Marquette

Aline Lefèvre

Academic supervisors: A. Vena / E. Dubreuil



LHUMAIN Laboratory & IES CNRS



Marquette

Objective/Motivation:

The SCENOSCOPE research program, lead by LHUMAIN Laboratory, aims to understand the actual visitors' experience of cultural sites, and the relations with the artwork and with each other. To do this, the laboratory invites the participation of the IES to develop an embedded device to capture indoor visitors' movements with the RFID technology.

Results:

We already have a prototype created by our teacher with Arduino on which we were able to produce programs to display a visitor path on a map using python. We created a new prototype to do the same things as the first prototype, but with new components to have a more powerful and more efficient board. The new prototype uses an STM32 microcontroller so we code the different functions in it.

Keywords: RFID, Localisation indoor, Embedded device, STM32, Python

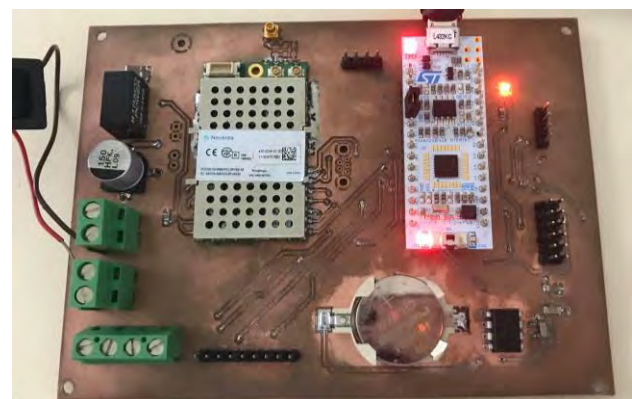

First and Second prototypes

Contact : aline.lefevre@etu.umontpellier.fr ; hugo.marquette@etu.umontpellier.fr

Cell Sensing Board Interface for Battery Systems

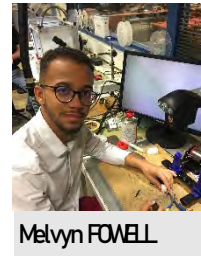

Microelectronics and Automation

Melvyn FOWELL



Academic supervisors:

E. Dubreuil

Northvolt, European supplier of sustainable, high-quality battery cells and systems.

Objective/Motivation:

Enable Northvolt Test Engineers and its customers to interface with battery modules. The goal is to provide a device allowing the end-user to have a total control over the battery modules with ISO 26262 in mind. The end-user can interact with battery modules simultaneously through the Cell Sensing Board Interface and can set various parameters, safety features, data loggers...

Results:

I mostly worked on the embedded software and product management of the first and second iteration of the Cell Sensing Board Interface (CSBI). We successfully delivered the CSBIv1 and v2. The product is working reliably and every feature has been implemented. However, a CSBIv3 will be developed as some hardware changes and optimisations have to be made.

Keywords: Embedded software; Battery Management; ISO26262; STM32; CAN; SPI; EEPROM; C++

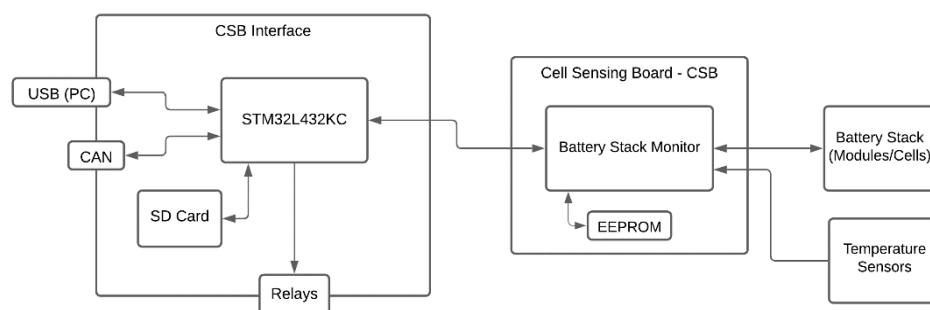

Cell Sensing Board Interface schematic and its relation to the other components

Contact : melvyn.fowell@protonmail.com

Development of an ultra-low-power underwater radio communication and location system for exploration robots

Microelectronics and Automation

Nicolas TROESCH

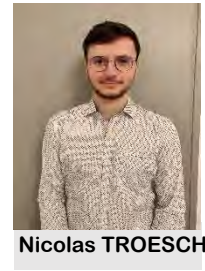

Academic supervisor:

Arnaud VENA

Objective/Motivation:

The goal of this project is to develop a device that will allow exploration robots to communicate and locate themselves during their karst exploration. During their diving sessions, divers are pulling cables for communication. We are using this cable as an antenna that emits electromagnetic waves in form of standing waves. Our device will be able to measure these electromagnetic waves and find his relative position to the cable by analysing the standing waves alongside the cable.

Results:

I have managed to assemble a prototype, with my Raspberry Pi and a software defined radio, that acts like a spectrum analyzer to measure and save electromagnetic waves from his surroundings. These measurements will be analyzed after being saved. I hope to find a relation between the saved signals and the relative position of the robot to the cable.

Keywords: Underwater / Radiowaves / Location / Communication

Contact : nicolas.troesch@etu.umontpellier.fr

Design and development of operating software for a medical device

Microelectronics and Automation

Raphael Bordoux

Academic supervisors: D. Andreu / A. Haiarrassary



Neurinnov

Objective/Motivation:

Imagine and Implement a part of a new software the company want to crate in order to use it in a medical field. This part must allow to link, with a graphic interface, different component stored in a database. The user must be able to create a "Setup" and link a "Stimulator", "Physical electrode Model", "Virtual Electrode", "Microprogram" and a "Scheduler" with predefined constraints.

Results:

I implement some of the modules and the differents links : Stimulator, Physical Electrode Model and the Virtual Electrode. I can save the Setup in the database, edit, and delete it.

Keywords: Software, Medical

Contact : raphael.bordoux@gmx.fr

The monitoring of operation of public vermicomposting toilets

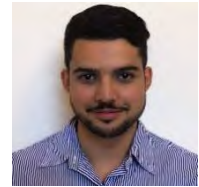

Samy El Manssouri

Microelectronics and Automation

Samy El Manssouri

Academic supervisors:

Arnaud VENA



Objective/Motivation:

The Sanisphere company is specialized in the design, manufacture and sale of dry public toilets with gravity separation. The company wants to better understand the behavior of natural ventilation which works in an autonomous way in their toilets. Today this system works and it has been used in all their toilets, but in some toilets the smell is still present, so the natural ventilation is not sufficient or is disturbed, that's why they want to create a natural ventilation monitoring device.

Results:

This project consists in creating a device based on sensors, which will allow the monitoring of various information in real time. The components have been chosen so as to have very low consumption, and also a battery adapted to the project which will allow to limit the power consumption to be empowered with a battery during 5 years of autonomy for our device. All the hardware part is done. For the software part, the codes of the various components were written, but not grouped into a single final code.

Keywords: DDRS, Arduino, sensors, monitoring device

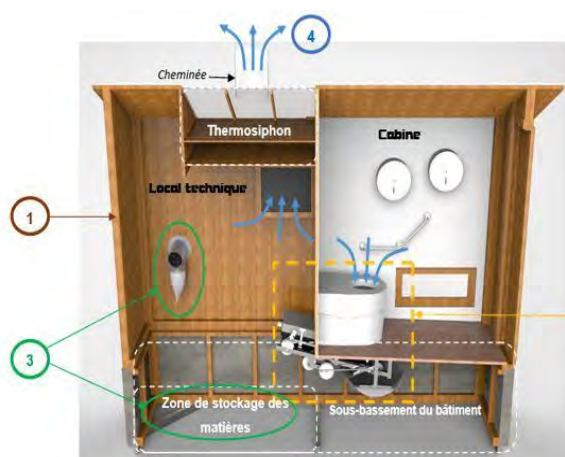

- ▶ 1. The building
- ▶ 2. The mechanical brick
- ▶ 3. the biological brick
- ▶ 4. The natural ventilation brick

Contact : samy.el-manssouri@etu.umontpellier.fr

Design and development of a current / voltage amplification stage for a nervous system stimulator

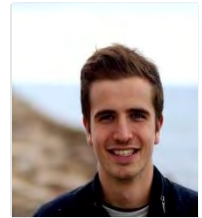

Van Overstraeten

Microelectronics and Automation

Marie Bodin Clément Van Overstraeten

Academic supervisors: D.Andreu/ G.Cathebras



Neurinnov



Bodin

Objective/Motivation:

Within the framework of the design of medical devices intended for the stimulation of the nervous system, a mixed analog / digital integrated circuit for current generation has been developed and manufactured. This is the SAFE chip. This circuit is designed for implanted stimulation applications and its current generation characteristics are too limited for use in external stimulation. This is how our project topic was born. So, we designed and tested a prototype circuit to amplify the current of the chip and allow external stimulation.

Results:

The work is carried out according to the specificities of the field of medical devices. They are subject to rigorous documentation and test with precise simulations. We have therefore made a circuit with a current amplification factor of 25 and simulations detailing the correct operation of the circuit.

Keywords: medical device, analog circuit, current amplifier

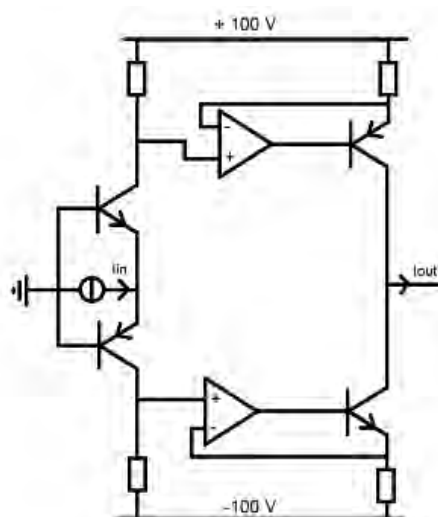

Contact : clement.van-overstraeten@etu.umontpellier.fr marie.bodin@etu.umontpellier.fr

Communicating Sensor For Submarin Robot



Xavier Bordes

Microelectronics and Automation

Xavier BORDES

Academic supervisor:

Eric Dubreuil



IFREMER

Objective/Motivation:

As part of IFREMER's activities in marine environments, certain missions consist of taking readings of certain physico-chemical parameters according to a defined protocol, and repeatable over campaigns over several years.

The goal of this project is to add a certain number of functionalities to an industrial sensor allowing the partial automation of these measurements.

Results:

To achieve the communicating sensor intended to automate the measurement readings, a Raspberry Pi 4 will serve as a controller in order to manage the communication for the control of the robot, the GSM communication, the collection of GPS data as well as the measurement readings from the fluorometer sensor.

Keywords: Fluorometer, Submersive Robots, Data Transmission



BlueRov Submarin Robot and Fluoroeter Sensor

Contact : xav.bor@hotmail.fr

Espace Immersif

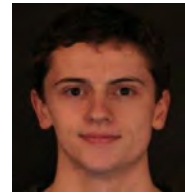

Thibault
Jacquesson

Microelectronics and Automation

Thibault JACQUESSON

Academic supervisor:

Pr. Alain Foucaran



IES Laboratory

Objective/Motivation:

The immersive space is a project that is part of the HUT project. The main goal of this project is to reproduce the sensation to be outside. It must take place in a 9m² room and to be easily transportable.

Results:

To do this, we manage different components (lights, fans, diffuser...) which they simulate the natural environment. We use and Human-Machine Interface, designed in VB.net and C#, which communicate with the components through an Arduino Board. The Arduino's role is creating the random effect of a natural space. To do that, we must design a firmware code which create random in time and in intensity.

Keywords: immersive space / HUT / VB.net / C# / C++

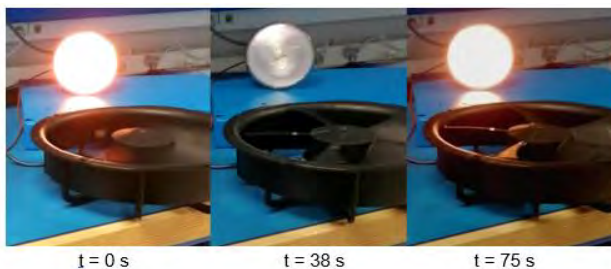

t = 0 s

t = 38 s

t = 75 s

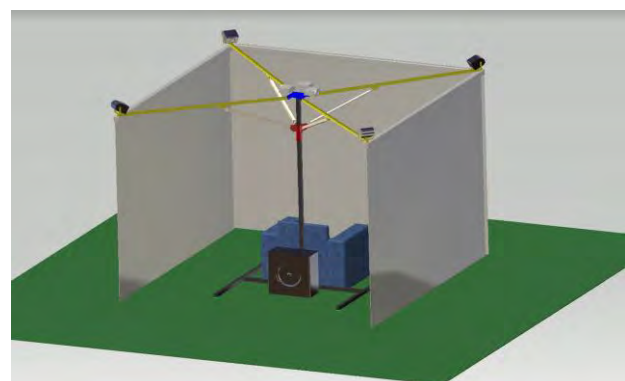

Lamps and fans at different moment

3D representation of the immersive space

Contact : thibault.jacquesson@gmail.com

STM32 clock trimming

Microelectronics and Automation

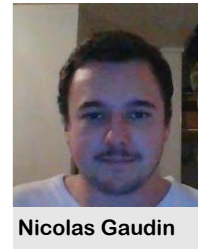

Nicolas Gaudin

Academic supervisors:

M. Comte / F. Azais



STMicroelectronics

Objective/Motivation:

The main objective is to use this project after microcontrollers production to trim their internal clocks. These tests are carried out with an industrial Automated Test Equipment (ATE) and represent a half of the product cost. We have to be quick and efficient.

Results:

We develop with different methods like scanning all trimming values, dichotomy, prediction using slope, polynomial using periods signal.

We do not have achieved the main goal of the project. During the project, I learn a lot about project management, and I am proud to practice what I learned during engineering school.

Keywords: STM32, clocks, algorithms, IP tests, trimming

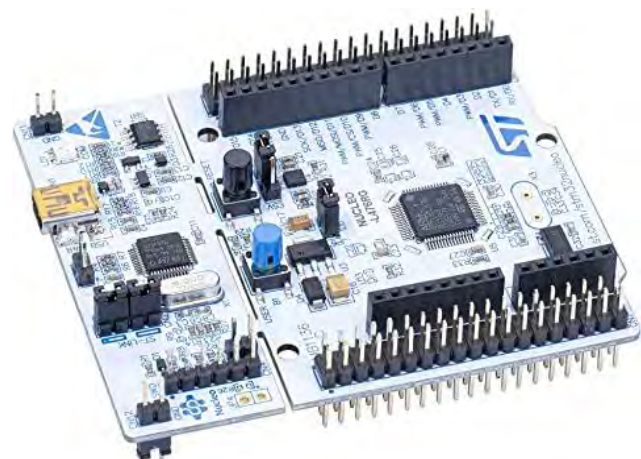

STM32L476RG (board in which I work)

Contact : gaudin.nicolas64@gmail.com

Code generator for robot controllers from URDF files

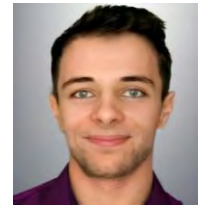

Microelectronics and Automation

Clément Metz



Academic supervisors: A. Crosnier / P. Fraise

LIRMM (Montpellier Laboratory of Computer Science, Robotics, and Microelectronics)

Objective/Motivation:

Developing control algorithms for robots is sometimes a long task doing it by hand. Moreover, most of the algorithms work numerically, so the code is not optimized. To help roboticists programming them, I create a software called URDFast. This is a code generator implementing these control algorithms automatically in an optimized way. This might be useful for beginners in robotics as well.

Results:

The software is able to generate kinematic control loops and all the functions needed to run them, such as forward kinematics and jacobians. The generated code is many times faster than a code written by hand and comes with a documentation to use it easily. Supported languages are Python, Julia and MATLAB.

Keywords: robotics, code generation, control, optimization, software development



Graphical User Interface of the developed software

Contact : clement.metz31@gmail.com

Electric bus simulator

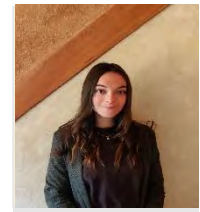

BONNEAU Coline

Microelectronics and Automation



ALSTOM



Academic supervisors:

Coline BONNEAU

Jean-Marc GALLIERE

Objective/Motivation:

The aim of this projet is to develop an electric bus charge simulator for the company Alstom. To perform this, we need to define the electric behavior of buses (with a load profile and a batterie gauge), and we need to visualize in real time the state of charge of each bus wich is in the simulation.

Results:

A program in C# has been developed. In this program, the user can chose a scenario (including a number of buses and chargers). Once the scenario is loaded, the user can visualize in real time the charge and the departure in service of each bus, and visualize the utilisation of each charger.

Keywords: Bus simulator/ WPF / C#



Contact : coline.bonneau@etu.umontpellier.fr

Feasibility of the Blockchain for the IoT



Eduardo
Pagnoncelli
Lorandi

Microelectronics and Automation

Eduardo Pagnoncelli Lorandi



Academic supervisors: Pascal Benoit, Loïc Dalmasso

Laboratoire d'Informatique, de Robotique et de Microélectronique de Montpellier (LIRMM)

Objective/Motivation:

With the emerging of smart-devices and their steady exchange of information through the internet (the so-called Internet of Things) it came also the need of a network protocol where the nodes of the system can properly communicate. This exchange of information must be fast, secure, and in some cases transparent. The objective of this project was to evaluate the use of a lightweight blockchain as the networking solution for communicating nodes in an Internet of Things environment. It was tested its feasibility in terms of latency, speed, and security. The blockchain protocol used was Nano, where some modifications in the source code were made in order to have a locally hosted Nano private network

Results:

There were some technical limitations that prevented to run all the desired benchmarks, but in the end, it was proven that some of those tests would only be really representative in a much bigger scale. Overall, the implementations that the Nano blockchain brings to the table circumvent the difficulties that prevented the use of low-power devices as nodes. Also the biggest limiting factor of Nano is the bandwidth and latency of connections, and not the processing power of its nodes, so using low-power devices is indeed feasible and will not bottleneck the network

Keywords: Blockchain Development, Blockchain, IoT, Nano, Bitcoin.

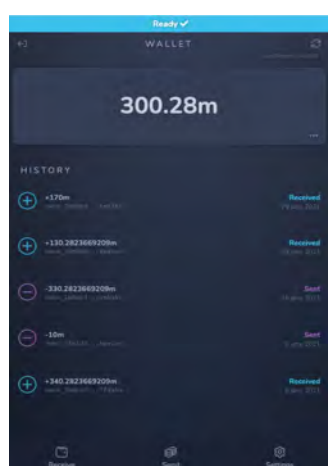

Wallet accessing an account in the private Network(1) and Graphic representation of blocks in a blockchain(2)

Contact : edulorandi@gmail.com

FOOD LIGHTING

Microelectronics and Automation



Hicham SI HADJ
MOHAND

HICHAM SI HADJ MOHAND

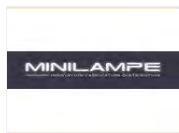

Academic supervisor: Béatrice PRADARELLI

Minilampe / Polytech Montpellier

Objective/Motivation:

Minilampe is working with EPTA which is the market leader in refrigeration. The project concerns the development of a prototype of light control for refrigerated cabinets. The aim of this project is to optimize the use of this lighting in shops when its use is not essential, but also for ecological, financial, and marketing purposes.

Results:

This prototype integrates lighting functions (choice of lighting color, brightness variation) with a manual mode variation and a presence sensor mode for automatic operations. 60% light intensity going down to save energy when the system is not used.

Keywords: Energy management approach.



Light control system



Color variation

Contact : hicham.si-hadj-mohand@etu.umontpellier.fr

Underwater Light Profiler



J. Benoit

Microelectronics and Automation

Jacques Benoit

Academic supervisor: L. Latorre



UMR MARBEC

Objective/Motivation:

The goal of this project is to develop a low cost, portable, compact light sensor to measure vertical patterns of photosynthetically active radiation (PAR). From these measurements the downwelling attenuation coefficient (K_d) can be calculated, which describes the rate at which light is lost as it moves through water, an important indicator of light availability.

Results:

We were able to make a small device and it was tested in real condition with great result.

Keywords: capteur Lumière Biologie Marine

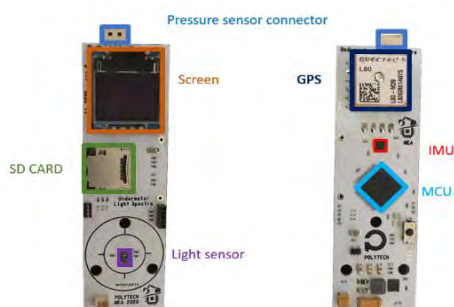
*Prototype*

Contact : jacques.benoit@etu.umontpellier.fr

IOWA LITE

Microelectronics and Automation



Julien Bianchi

Academic supervisor: L. Latorre



Objective/Motivation:

Starting from the existing IOWA SDK in its latest release, the purpose of this project is to think about the different axes to study by reducing the size of a customer code as much as possible. This study may include a reduction of the functionalities supported within the limit of the standard for a specific use. It may also include the use of certain toolchain which more or less optimizes the use of resources. The ultimate goal is to reduce the code of the IOWA SDK by at least 40% in order to implement the code on electronic cards with very limited memory flash (around 60 kB).

Results:

The final version of the IOWA SDK has been reduced by 75%. As a result, the SDK size is less than 20 kb. The specifications of the lite version are:

- An optimized compiler with LTO activation (Link Time Optimization) to reduce code size for the entire SDK and not just for a single source file. Selection of the best options of the GCC toolchain for compilation adapted to Flash memory constraints (-Os, -ffunction-sections, -ffdata-sections...).
- A new IOWA configurations with functionalities adapted for basic IoT applications with limited resources. Deactivation of the security layer and the logs.
- A complete study of the different approaches to reduce the memory size code, useful for any type of software development. It concerns the structure of the code, toolchain and choice of compiler.

Keywords: IoT, code size optimization, C, LwM2M, toolchain, compiler, flash memory

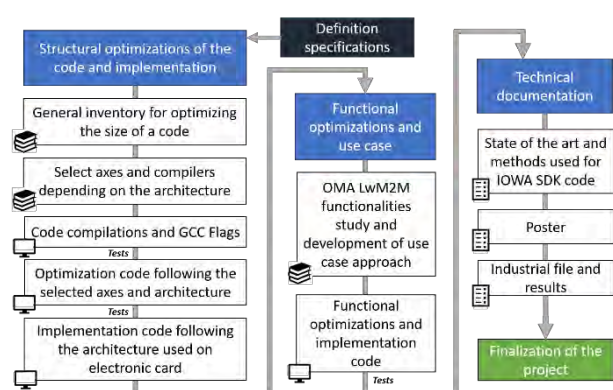

Iowa logo (left) / Diagram of the project steps and tasks (right)

Contact : julien.bianchi@etu.umontpellier.fr

Control of an underwater robot with ROS



Microelectronics and Automation

Maxime COGNÉ



Academic supervisors: Karen GODARY DE-JEAN

Polytech Montpellier / LIRMM

Objective/Motivation:

The objective of the project is first to design the ROS architecture of the existing command of an underwater robot. Then is to integrate the features of the command into this architecture. In the end, this project is part of a bigger project which is the realisation of an underwater robot for underwater environment observation.

Results:

First, I imagined and designed the architecture of the command for the robot with ROS composed by multiple nodes for each feature of the robot and topics to allow them to communicate between them. Then I have created this architecture with ROS2 and wrote a documentation for users to be able to use the code.

Finally, I have implemented a part of the existing code into my architecture.

Keywords: Robotics / ROS /underwater robot / robot controller

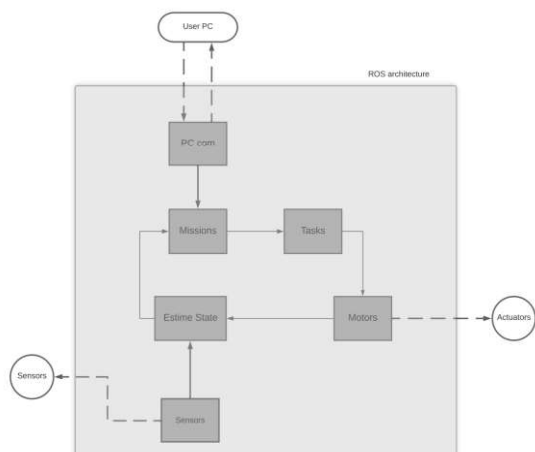

The ROS2 architecture



The robot Réri

Contact : maxime.cognie@etu.umontpellier.fr

Répétiteur de vol / Fly repeater



PRÊCHEUR

Microelectronics and Automation

Oscar PRÊCHEUR

Academic supervisors: LATORRE/DARIDON



LMGC/CEM

Objective/Motivation:

Nacra 17 boats are sports catamarans. They are devoid of electronics on their board which makes it difficult to improve the precise analysis during training. The overall project proposed by the Mediterranean Training Center is to design an autonomous system including sensors, computer, and screen. It had to retrieve the navigation data, display it on the screen and save it. This project is the continuation of a similar project begun last year. I had to improve it to make it able to answer at the demand of the Mediterranean Training Center. During my End Studies Project, I focused on the software part of the system. I had to develop the graphical interfaces of the dashboard and the debriefing functions.

Results:

This project is not finished. There are many ways to improve it and make it efficient. The graphical interfaces are working but several functions are missing. The goal was not to finish the project but to create a base for another developer to make the system usable in the future. Now, the system is able to read sensor's data simulated, to display them on a dashboard and memorize them.

Keywords: Dashboard, Sailing Ship, Debriefing, Graphic Interface, Qt, C++, QML

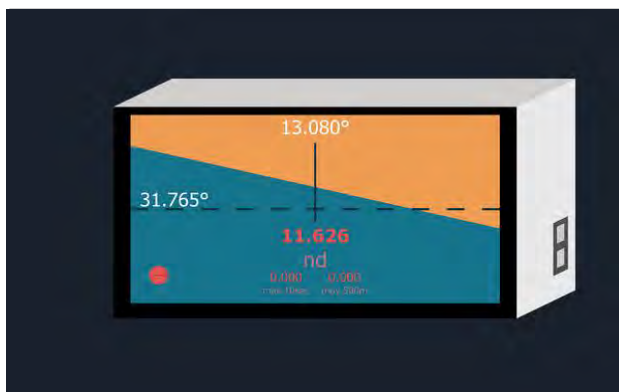

Screenshots of dashboard and debriefing interfaces

Contact: oscar.precheur@gmail.com/ laurent.latorre@umontpellier.fr/ loic.daridon@umontpellier.fr

Analyse énergétique de la consommation du mini 6.5 "YES"

Microelectronics and Automation

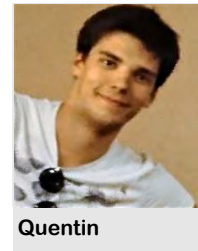

Quentin

Quentin Ponzio



LMGC, IES

Academic supervisors: Loic Daridon, Jerome Castellon

Objective/Motivation:

Analyse the electrical consumption of divers elements on a mini 6.5 Boat to optimize the energy autonomy

Results:

Live mesure system that can be used in real time with a smartphone to monitor energy consumption and store the data on a micro SD card

Keywords: boat, electricity, current, monitoring, energy, application



©Didier Hillaire

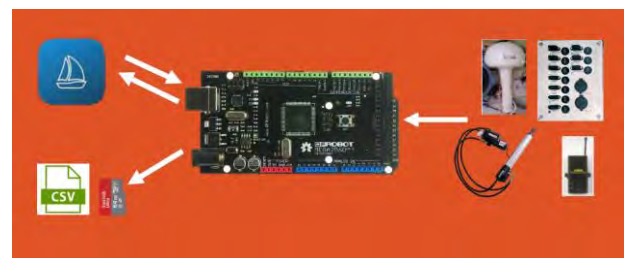

On the right : Mini 6.5 "YES" winning a race, On the left : Schema of the system

Contact : quentin.ponzo@etu.umontpellier.fr

Apprenticeship : Docking Station and Zigbee Bridge

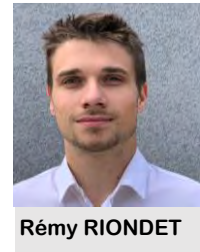

Rémy RIONDET

Microelectronics and Automation



Picodev
PICODEV

Rémy RIONDET

Academic supervisor:

E. DUBREUIL

Company supervisor:

S. MASSON

Objective/Motivation:

Develop a Docking Station to connect an Android smartphone to HID devices (like a keyboard). Using the charging station with USB ports.

Develop the electrical circuit of a bridge for a Zigbee module. Alimentation and protection.

+ test the mesh communication protocol

Results:

Control Android Smartphone with HID device. It become host of the communication and HID are the clients. For example, some keyboard, computer mouse, video screen or storage device can be plugged. Check up the level of water into some tank, fully automatically. All the data are gathered into a central office where it is really easy to obtain information.

Keywords:

USB protocol Docking Station HID sotware

Electrical Circuit Zigbee Bridge Hardware / mesh communication protocol



Docking Station for USB HID



ZigBee communication schematic

Contact : remy@picodev.fr

Evaluation platform for high performances microcontroller architectures in an edge computing context



Romain

Microelectronics and Automation

Romain PESSATO



Academic supervisors: Pascal Benoit, Théo Soriano

LIRMM

LIRMM (Robotics and Microelectronics French Laboratory), Montpellier, France

Objective/Motivation:

Edge Computing strategy consists in analysing the data collected by a sensor node locally. The objective is to limit the use of energy-intensive communication devices (such as radio) resulting in longer autonomy while reducing the amount of data on the network. In this context, the LIRMM is developing a edge computing dedicated microcontroller architecture for research works. The objective of this project is to develop a person detection application compatible with this architecture.

Results:

First, a state-of-the-art of machine learning solutions for person detection applications has been made and a solution (based on convnutional neural network) has been chosen. After that, the solution (YOLO machine learning model) has been implemented on a computer. Next, another solution (TensorFlow machine learning model) has been implemented on STM32 microcontroller which works with a camera. After optimization, the final application is about 280kB. Finally, the last step consisted in transferring this application toward a different microcontroller architecture developed by the LIRMM based on the open source RISC-V instruction set.

Keywords: Edge Computing, Machine Learning, Person Detection, Microcontroller

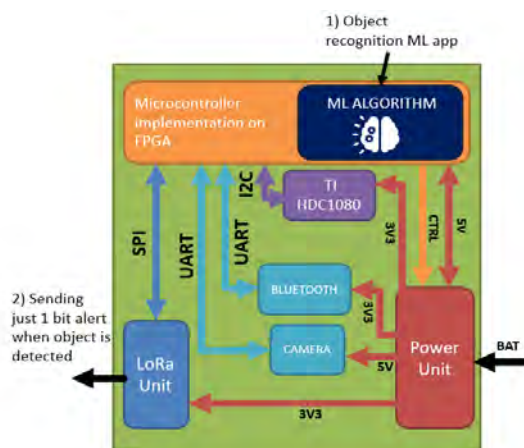

System architecture (left) and an example of a result (right)

Contact : romainpessato@gmail.com

Conception and development of an autonomous sensor for the motion

Microelectronics and Automation

Geoffrey BELARD

Manon SALLES

Academic supervisors: D.ANDREU / L.LAPIERRE



Polytech / Lirmm

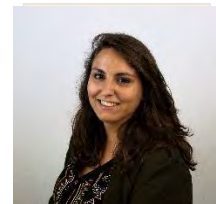

Salles Manon

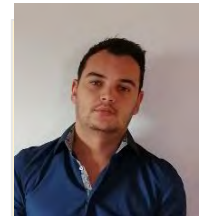

BELARD Geoffrey

Objective/Motivation:

The goal of this project is to allow quadriplegic patients who have been implanted with the Hand Stimulator HandyGrasp™ to command the device by means of shoulder movements.

To do so, movements are measured using inertial measurement units whose data is processed to detect and classify the events from which the command is expressed.

Results:

The processing of IMU data has been finalized. After removing offsets and severity, event detection has been improved. We then developed an approach for classifying these events based on reasoning in position space. Indeed, by comparing the distance to the top and front planes (defined during the calibration phase) of our movements in position and in speed, we obtain a rather satisfactory classification of events.

Keywords: medical devices, inertial measurement units, event classification, computer science.



Contact : manon.salles@etu.umontpellier.fr ; geoffrey.belard@etu.umontpellier.fr



Modeling and analysis of rolling contact fatigue in a gear tooth

Mechanical Engineering and Interactive Design

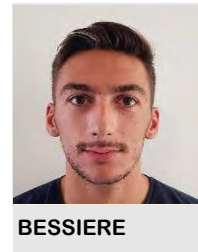

Thibault Bessiere



Academic supervisor:

Mathieu Renouf

LMGC Montpellier, CNRS

Objective/Motivation:

Represent the rolling contact fatigue thanks to a numerical modeling at the granular scale, highlight the phenomenon of damage in the model from a numerical method DEM / FEM. Show the influence of the influencing parameters of the model on the initiation cycle of microcracks

Results:

The modeling is not yet representative of the real behavior of a gear tooth in rolling contact fatigue, it nevertheless makes it possible to obtain microcracks, their cycle of appearance can then be linked to the influential parameters of the domain: domain size, grain size.

Keywords: rolling contact fatigue, damage, FEM/ DEM, cohesive zone model (CZM), granular

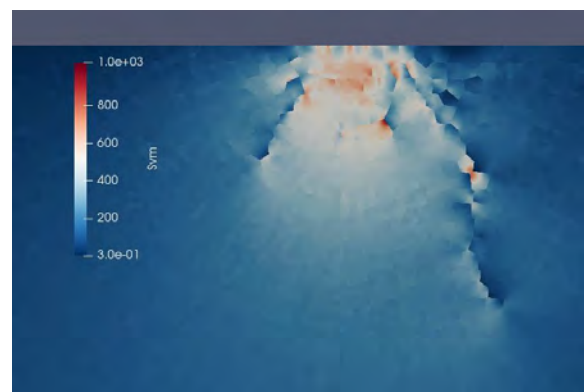
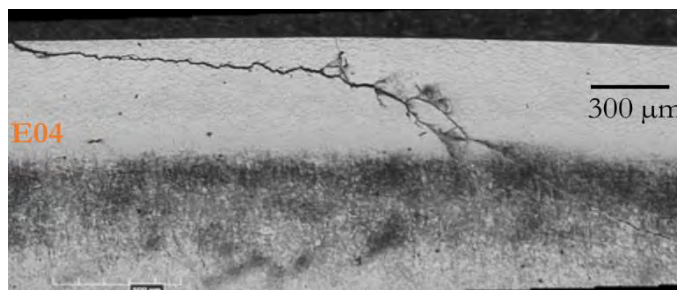

visualization of a crack on a mesoscopic scale; numerical representation

Contact : thibault.bessiere@etu.umontpellier.fr

release of a rubber tire from its steel mold



Mechanical Engineering and Interactive Design

MICHELIN



LABORATOIRE
de MÉCANIQUE
et GÉNIE CIVIL

Academic supervisor: Y. Monerie

LMGC & MICHELIN



William LE GOFF

Objective/Motivation:

The problem considered is the release of a rubber tire from its steel mold. This report is based on numerical simulations carried out using the LMGC90 software. By using the finite elements method, phenomena of large dynamic deformations were modeled in 2D, with a neo-Hookean constitutive law and a modeling of the unilateral rubbing contact and cohesive contact.

Results:

The report make severale observations about impact of rubbing contact, cohesive contact and hyperelastic deformations. It also describe the numerical tricks used and difficulties encountered.

Keywords: Numerical simulation, rubber tire, hyperelasticity, contact dynamic



Simulated groov of rubber tire

Contact : William.le-goff@etu.umontpellier.fr

Dismantling scenario of Magnesium's furnace

Mechanical Engineering and Interactive Design



Hugo SOLEILHAVOUP



Academic supervisors : M. Vivien LAMEILLE

Orano Démantèlement & Services

Objective/Motivation :

I had the opportunity to work on the installation Magnesium at the Malvesi site, close to Narbonne. The final objective is to safely evacuate 12 furnaces, of approximately 10 tons, as unitary parts to the company ANDRA, which is able to manage this type of waste. Beforehand, it will be necessary to remove the asbestos elements present on the furnaces. The objective is therefore to optimize the cost of this intervention, while guaranteeing the lowest possible levels of dust and exposure. The design office, in which I am doing my sandwich course, has been asked to think about the design of a waterproof enclosure system to locally isolate the asbestos elements. At the end of this assignment, it was necessary to draft the products specifications.

Results :

The preliminary step to the implementation of this project is to assimilate the problems and expectations of the managers. This involves a phase of mastering the input data as well as a study of the feedback. This is followed by the numerical modeling of the types of solution to be supplied via the SolidWorks design software. In parallel, as part of a cost optimization approach, possible improvements must be considered. This work is an integral part of my abilities as a mechanical engineering student.

Once validated during a design review, and in order to prepare the tender process related to this service, I integrated the needs and principles of the expected products through several technical specifications. Then, it will be necessary to consult the suppliers with a tender phase. I will therefore have to attend the technical analysis to choose the service provider in charge of the project.

Keywords : Dismantling - Nuclear - Studies - Engineer - Planning - Financial estimate - Scenario - SolidWorks



Contact : hugosoleilhavoup@hotmail.com



Simulation of fluid flow for porous ceramic bioreactors



Jeffrey
GERARD

Mechanical Engineering and Interactive Design

Jeffrey GERARD



Academic supervisors: Joe Alexandersen/Julien Laget/Andre Crosnier

Polytech Montpellier / University of Southern Denmark

Objective/Motivation:

The objective of this PFE is to model both the chemical process of alcoholic fermentation, and the reactive flow of glucose within a pipe containing a porous bioreactor. Certain avenues for improving the production of ethanol within the pipe will be explored, as for exemple the use of shape optimization.

Results:

The results obtained show that in order to optimize the production of ethanol, it is necessary to include holes within the porous obstacle. These holes should be elliptical, and may undergo shape optimization to improve production. Finally, stacking several bioreactors seems to be an interesting avenue in improving the process.

Keywords: Numerical simulation, fluid mechanics, chemistry, DDRS, COMSOL

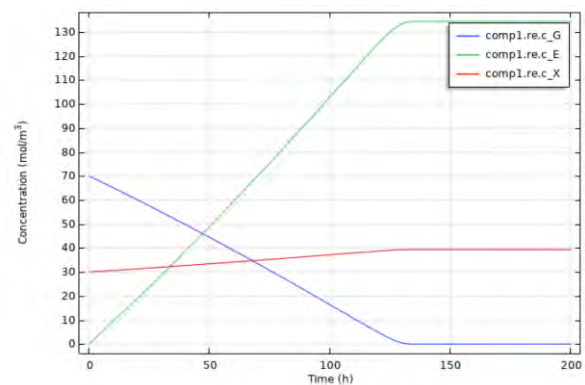
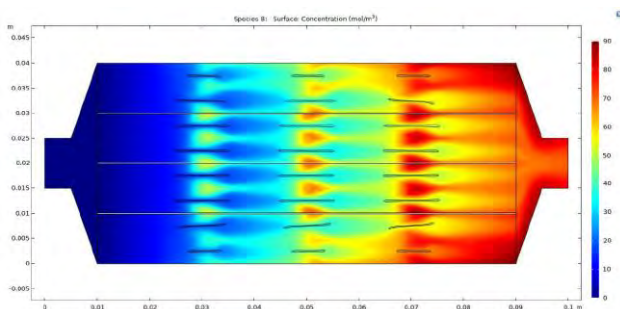

Contact : jeffrey.gerard@etu.umontpellier.fr

Matériaux fibreux modèles



Mechanical Engineering and Interactive Design

Jimmy Teixeira



Academic supervisors: C.Wagner-Kocher /
P.Cañadas / C.Piao

Objective/Motivation:

The ultimate goal of this major project is to understand the mechanical behavior of connective tissue. Synthetic materials are expected to reproduce the behaviour of biological materials by mimicking their structure and mechanical characteristics. The focus is on connective tissues: composites of fibers and matrix made of collagen and elastin respectively. In this work, we studied model materials composed of a matrix and several straight or helical fibers.

Results:

Simulation: A 3D composite made of a single fiber and a cube matrix has been modeled, and tensile test have been simulated. Convergence has been proven for both straight and helix fiber. The models have been computed for different number of fibers and Poisson coefficients. **Experiments:** Tensile tests on crafted composites have been made and analyzed.

Keywords: Ansys; Solidworks; Tensile test; Fiber; Composite; Matrix; Helix; Medical; Biological; Tissues;

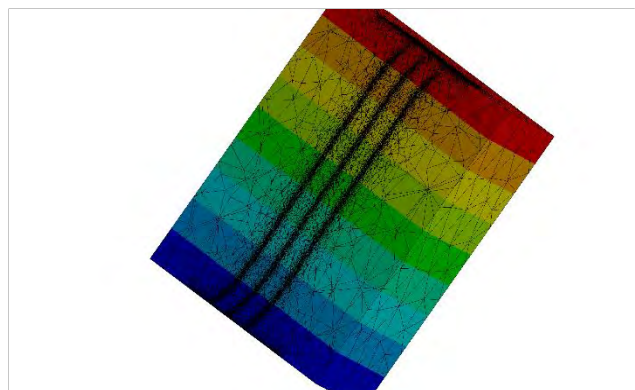
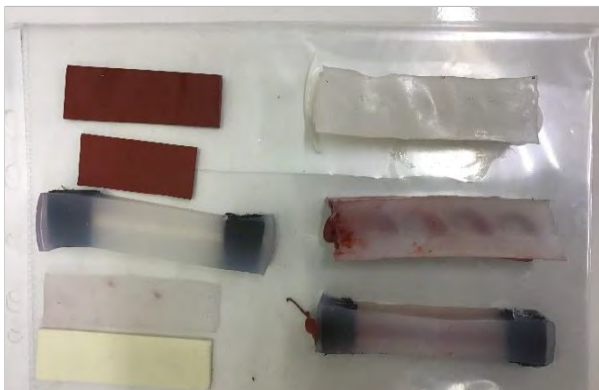

Left: All the test pieces used for tensile tests (straight and helix fiber). Right: Composite numeric model.

Contact : jimmy.teixeira@etu.umontpellier.fr

Design and manufacture of a syringe pump for 3D printing of pasty materials



Lory

Mechanical Engineering and Interactive Design

Justine Lory

Academic supervisor: Yvan Duhamel



Institut Charles Gerhardt of Montpellier

Objective/Motivation:

Motivation : Nuclear power generation can release strontium and cesium ions through the power plant water. One solution is to circulate radioactive water through a material synthesized from a 3D printed paste.

Objective : Design and manufacture a system for 3D printing pasty materials.

Results:

The system was designed on Creo, and the strength of the most important mechanical part was tested (Fig 1). The part could then be optimized, the material was removed at the least constrained places and added at the most constrained. Then the system was 3D printed and assembled.

Keywords: design, stress analysis, 3D printing

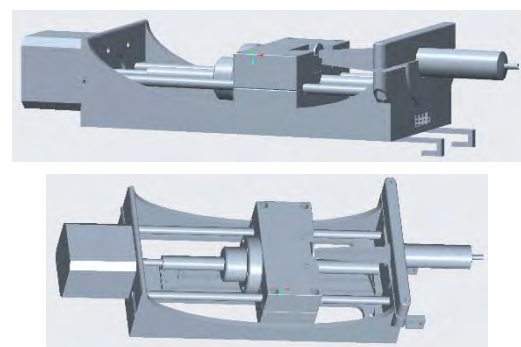
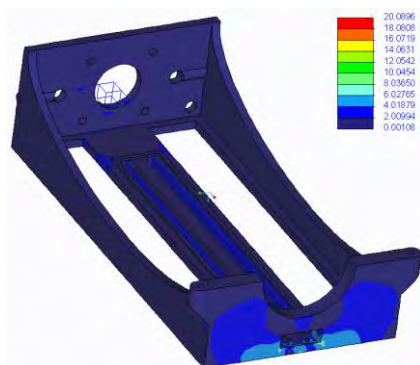

Fig : 1 simulation of the stress in the main part of the system

Fig 2 : assembly of designed parts on Creo

Contact : justine.lory@outlook.com

Thermal characterization of a carbon-neutral cloud



Lucas Cuisset

Mechanical Engineering and Interactive Design

Lucas Cuisset

Academic supervisor: F. Nicoud



LIRMM (Laboratoire d'informatique, de robotique et de microélectronique de Montpellier)

Objective/Motivation:

The aim of the project is to determine the thermal features of a solar energy-based cloud. This cloud has been made to answer back the environmental problem caused by numerical electrical consumption.

Results:

According to the technical specifications of the cloud and numerical modelling results, a cooling solution using heat pipes is found.

Keywords: cloud / DDRS / finite element / thermal analysis

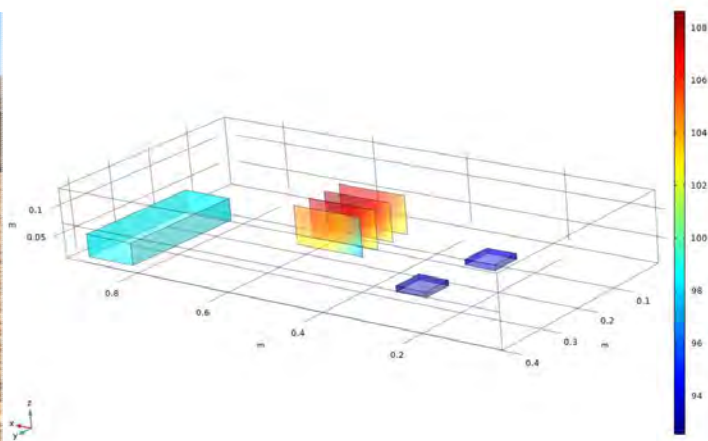

The cloud on the Polytech Montpellier's rooftop and the surface temperature of electronic components in °C

Contact : lucas.cuisset@etu.umontpellier.fr

Head stabilization during controlled linear acceleration of seated volunteers: influence of several parameters

Mechanical Engineering and Interactive Design



L. Depieds

DEPIEDS Lucas

Academic supervisors:

B. Sandoz - Y. Monerie



Institut de Biomécanique Humaine Georges Charpak

Objective/Motivation:

The number of vehicles has increased, causing more collisions conducting to high frequency whiplash injuries. Associated disorder are becoming a major social, economic and health issue. This study is conducted to have a better understanding of the head/neck complex behavior during simulated rear impact, trying to evaluate the flexion/extension of the cervical spine and parameters which could influence it.

Results:

Head kinematics has been recorded with Inertial Measurements Units (IMU) and data were analysed with Matlab to understand head movements and create statistics to see how several parameters influence these rotations.

Keywords: Biomechanics, Motion Analysis, Whiplash, IMU, Matlab

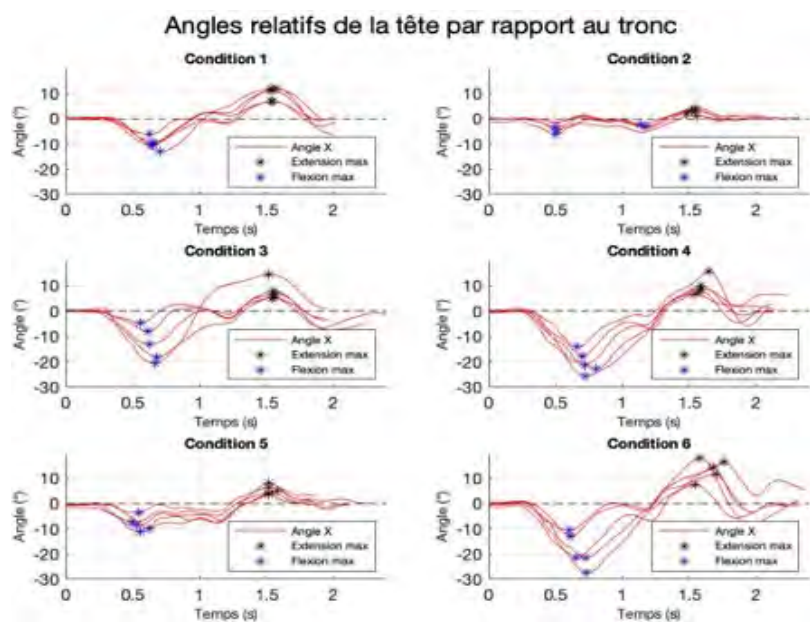

Contact: lucasdepieds@gmail.com - lucas.depieds@etu.umontpellier.fr

Progressive topological optimization by smoothing and remeshing

Mechanical Engineering and Interactive Design

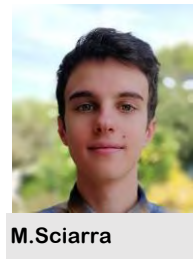

Maugan Sciarra

Academic supervisor:

Y. Monerie



Polytech Montpellier

Objective/Motivation:

This projet is devoted to the development of an iterative smoothing-meshing algorithm for topological optimization. The goal is to perform incremental optimization calculation while smoothing the shape of consecutive results. Local stress concentration due to removing finite elements are thus avoided.

Results:

The program created is based on the Python language and on the Cast3m, Paraview and GMSH softwares. . A geometrical and mechanical study of the solutions shows that it is possible to obtain solutions of different shapes for the same problem according to the given parameters. Mechanically this operation seems to lead to a better global distribution of the stress.

Keywords: Topological optimization, Cast3m, Python

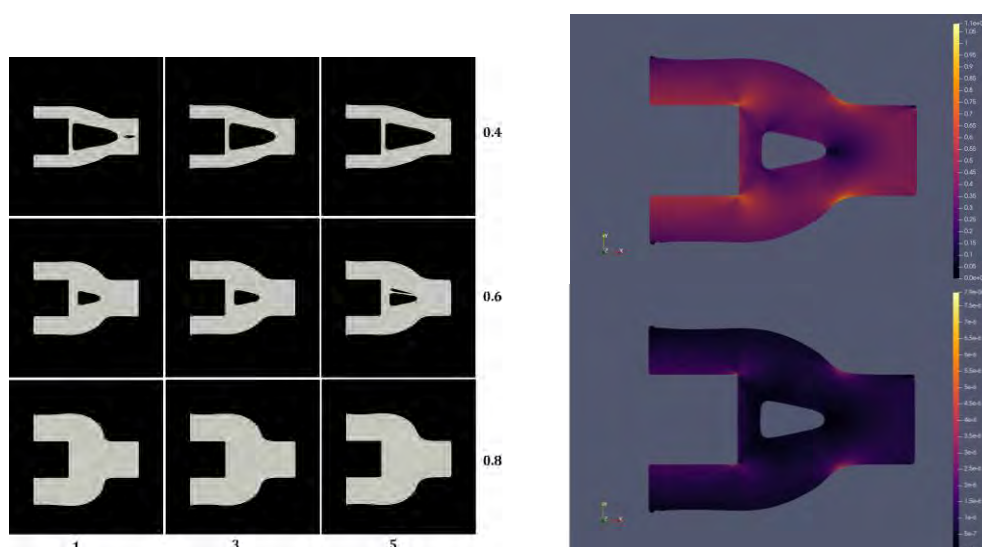

Different results obtained for geometric analysis, and mechanical analysis

Contact : maugan,sciarra@etu.umontpellier.fr

Design and production of an exoskeleton prototype



FACHE Quentin

Quentin FACHE



Academic supervisors

P. Fraise/ A. Crosnier

Laboratory of Computer Science, Robotics and Microelectronics of Montpellier (LIRMM)

Objective/Motivation:

We aim at designing a passive exoskeleton assisting a human operator during exhausting tasks. This work includes a preliminary mechanical design phase on SolidWorks followed by a design improvement with topological optimization on Castem. A proof of concept is proposed to be carried out in 3D printing.

Results:

The shape optimization on Castem gives expected results that minimizes the volume of materials while meeting the technical constraints. The exoskeleton is lightweight, wearable and modular. One interesting add-on feature uses two torsion springs on elbow and shoulder joints which assists well the human operator in carrying object.

Keywords: passive exoskeleton, topological optimization, Design, Castem, Solidworks

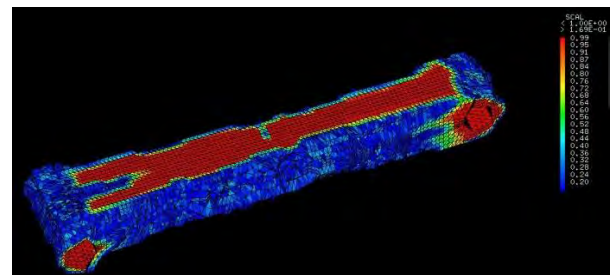
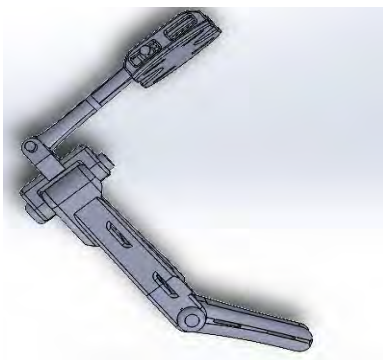

Contact : quentin.fache80@gmail.com

Design and prototyping of an automated system managing a tube filling process for PCR testing



Belbey Kévin

Mechanical Engineering and Interactive Design

Kévin Belbey

Joey DAGAUD

Academic supervisors: Aurelie Marchal

Cédric Reynaud

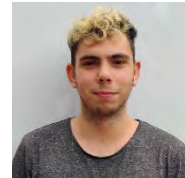

Dagaud Joey



Bioaxiome

Objective/Motivation:

The objective of this project is to design and prototype an automated system that could manage the process of filling tube for PCR testing of Bioaxiome Laboratory based at Nimes. I worked with a student from Microelectronics and Automation. We had to design a global solution regarding constraints imposed by Bioaxiome.

Results:

We found a global solution based on a Delta robot. With solutions for screwing step and filling step that we had to study the faisability. And we made the robot fonctionnal but not optimised

Keywords: Mechanical, PCR test, Robotics, 3D printing, Fonctionnal analysis

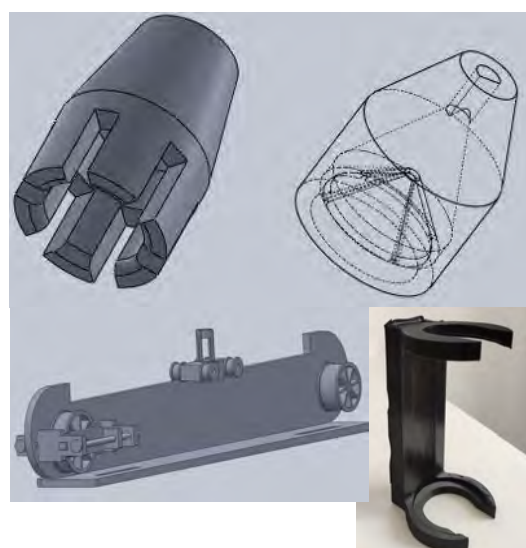

Contact : joey.dagaud@gmail.com ; belbeyk@gmail.com

Numerical modelling of the link between the heat wave velocity and the sap flow velocity in plants.

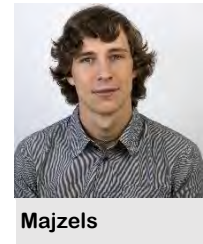

Mechanical Engineering and Interactive Design

Achille MAJZELS

Academic supervisors: H. Louche / J. Laget



Objective/Motivation:

The sap flux velocity in plants is an indicator of their health state. By heating the surface of the stem for a few moments, it is possible to visualize the movement of a heat wave with a thermal imaging camera. The knowledge of some physical properties of the plant then enable to find the value of the sap flow velocity. The objective of this project is to produce a numerical model that relates the sap flow and the heat wave velocity. Subsequently, the model will be used to evaluate the influence of some parameters and will be compared with experimental results and previous research.

Results:

All the results are based on a 2D axisymmetric model built with Fluent and made up of heartwood, sapwood, internal bark and external bark. The model shows that when the sap flow increases, the heat wave velocity rises up but remains lower than the sap flow velocity. Moreover, when the heat wave velocity calculated by the simulation is inserted in the Marshall formula, it gives results 3 times higher to those of the Fluent model. The model does not claim to bring exact results, but rather an approximation of reality which give trends and can be improved.

Keywords: Heat Wave/Sap Flux/Velocity/Numerical Model/Stem/Ansys Fluent

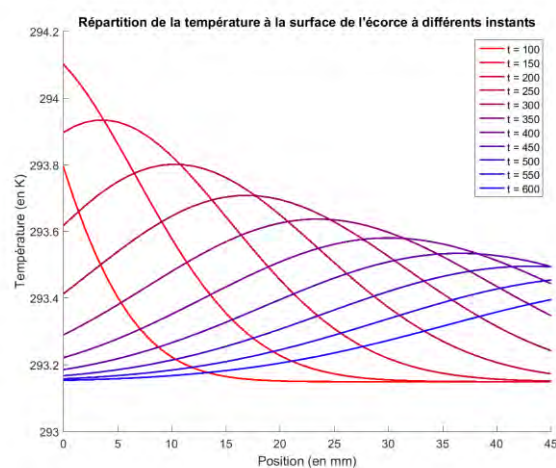
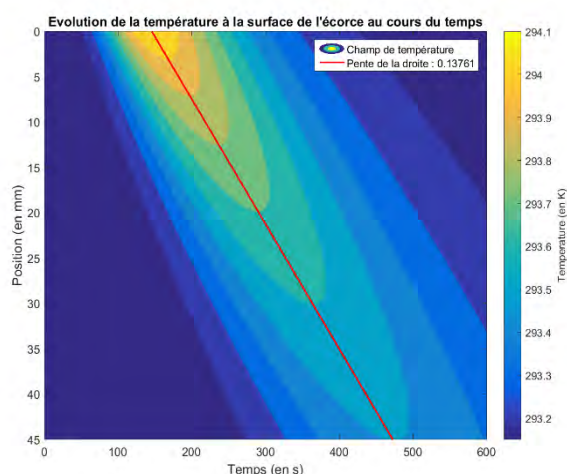

Contact : achille.majzels@etu.umontpellier.fr

Développement de l'électronique embarqué et son intégration sur l'ASV

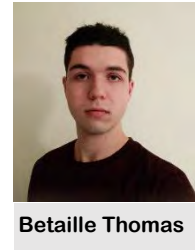

Betaille Thomas

Mechanical Engineering and Interactive Design

Betaille Thomas

Academic supervisor: L. Daridon

POLYTECH
MONTPELLIER

Polytech Montpellier

Objective/Motivation:

The goal of the project was to develop a system to control the foils of an Autonomous Surface Vehicule (ASV), using linear actuators and improve the structure of the ASV in order to support these actuators. Also the goals was to create a platform to test the controls of a wing above the ship

Results:

The fixation for the actuator developed and will be machined soon, the test platform is still a prototype

Keywords: ASV, Boat, Actuators

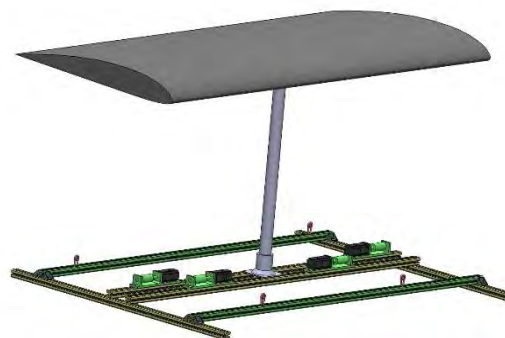
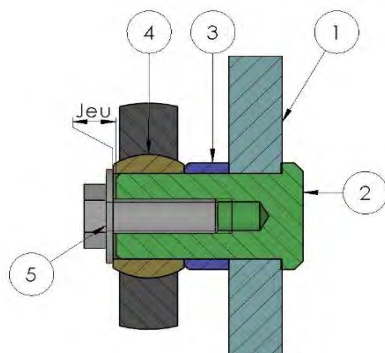
*Actuator fixation and the test platform*

Contact : thomas.betaille@etu.umontpellier.fr

Study of the mechanical behaviour under uni-axial stress of fibrous materials obtained by Jetspray

Mechanical Engineering and Interactive Design



Légier Florent



Academic supervisors:

C. Wagner-Kocher, P. Cañadas and J. Barés

Laboratoire de Mécanique et de Génie Civil de Montpellier - Equipe BIOTIC

Objective/Motivation:

The study of biomimetic fibrous materials plays a key role in the field of regenerative medicine. In this project, the influence of manufacturing parameters on the mechanical properties of the materials obtained by Jetspray is studied. This was achieved by uniaxial tension tests. Then, a first prototype creep program on an original tensile device using a printer scanner was developed.

Results:

The polymer concentration is identified as the parameter having the greatest influence while the spraying distance plays a lesser role. Tensile tests for different load speeds show dissipative effects. The creep program allows to attain the target force and to keep it constant over time.

Keywords: Jetspray-Tensile tests-Creep-Fibre

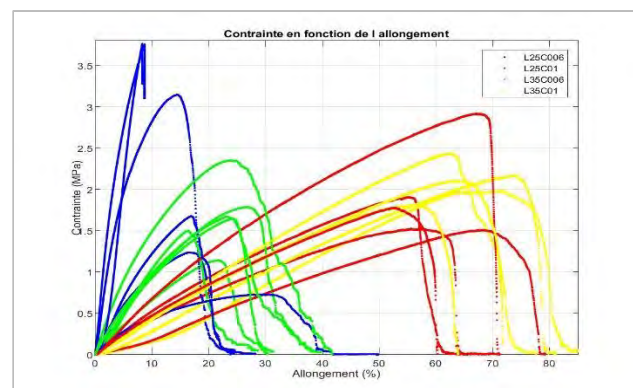

Picture 1: Results of tensile tests, stress depending on strain for 4 different materials- Picture 2: Picture during tensile tests:

Contact : flegier13@laposte.net

Machine learning to model flow diverters in hemodynamical simulations

Mechanical Engineering and Interactive Design



Guillaume Grosjean

Guillaume Grosjean

Academic supervisor: F. Nicoud

Sim&Cure

Objective/Motivation:

Flow diverters are efficient devices to treat cerebral aneurysms. An efficient method being developed by IMAG in collaboration with Sim&Cure (Thesis of Alain Berod, 2017-21) enables to numerically simulate the effect of flow diverters on the blood flow. This method requires information about an undisturbed upstream velocity of reference that today's method struggles to reconstitue. The aim of this project is to use machine learning, particularly deep learning with artificial neural networks, to reconstitue such a velocity.

Results:

An artificial neural network is implemented and enriched with machine learning methods by making use of the TensorFlow library (www.tensorflow.org). This leads to a model able to reconstitue a proper reference velocity with a better precision than the original method. Extension to 3D situations remains to be done.

Keywords: Machine Learning, Artificial Neural Networks, Biomedical, CFD

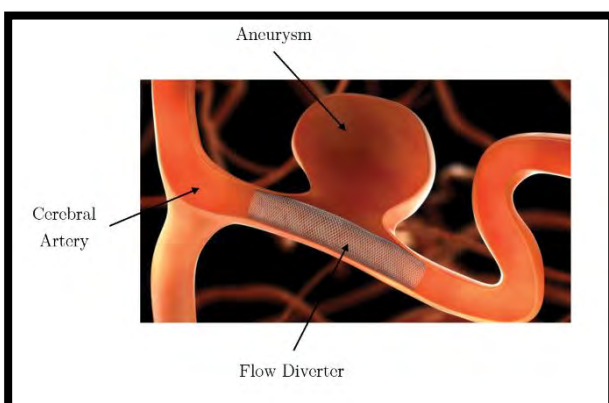

Intracranial aneurysms treated with flow diverter.

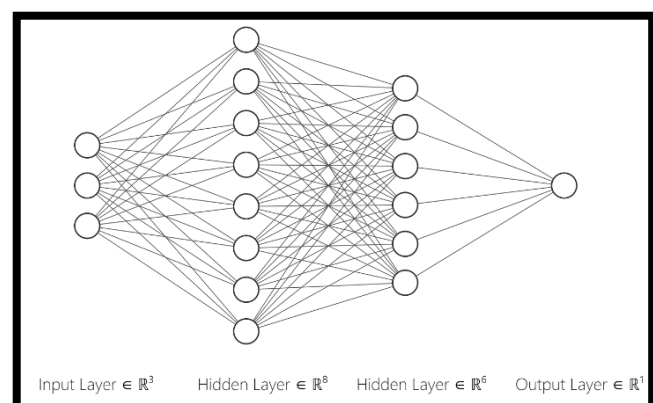

Feedforward artificial neural network.

Contact : guillaume.grosjean@etu.umontpellier.fr

Project Management : Maintenance Internalisation



Kévin Marques

Mechanical Engineering and Interactive Design

Kévin Marques



Academic supervisor:

Aurélie Marchal

SNCF Réseau : EIV Quercy-Corrèze

Objective/Motivation:

One of the main objectives given to me was to establish a quality management project. The bogies are currently subcontracted to another establishment. The EIV QC would like to internalize their bogies within the site. For this, it will be necessary to discuss the investments to be made as well as the maintenance costs that this requires.

Results:

To lead this project, a process defining all the maintenance steps was carried out. This made it possible to quantify all the costs linked to each process. We obtained that the maintenance of a bogie amounted to approximately € 36,000, including € 4,500 for subcontracting. Investments in tools and machines of 1.5 million euros are expected to internalize their bogies.

Keywords: Project management, quality engineering, digitalization

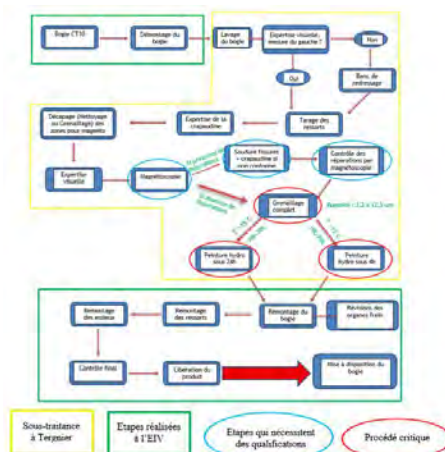

Maintenance steps for a bogie-----Costs relating to this process and investments to be made.

Contact : kevin.marques01@etu.umontpellier.fr ; kevmarq@hotmail.fr

Optimization of a passive sampler for a diagnosis of contamination of port areas



Morgane Hayoun

Mechanical Engineering and Interactive Design

Morgane Hayoun



Academic supervisors: Aurélie Marchal
Cédric Reynaud

Chrystelle Bancon, Laboratory HSM

Objective/Motivation:

Design supports for different passive samplers. It allow researchers at the Montpellier hydro-sciences laboratory to easily place these sensors in the water.

Results:

Due to sanitary constraints and construction delays, it is complicated to access the site. Initial tests have been carried out in the HSM laboratory. They are very conclusive, the supports are very practical and easy to use. Tests in real conditions will be carried out as soon as the situation permits.

Keywords: Design, 3d printing

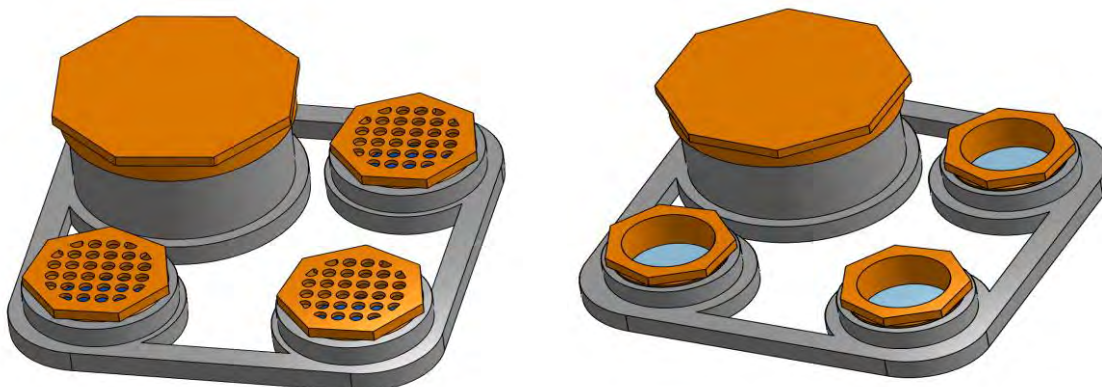

Supports

Contact : morgane.hayoun@gmail.com

Energy management of a mini sailboat 6.5



Mechanical Engineering and Interactive Design

BRU Salomé



Academic supervisor: L. Daridon

Polytech Montpellier/LMGC/IES/CEM

Objective/Motivation:

The aim of this project is to carry out a numerical simulation over years to recover the forces exerted by the water on a boat rudder.

Simulations will be carried out for different speeds, different angles of incidence, different rudder angles in the fluid and different proportions of rudder in the water.

Results:

The desired information could be retrieved thanks to numerical simulations. By making a simplified 2D kinematic model of the rudder-bar system, it was possible to link the forces exerted by the water on the rudders and the forces exerted by the skipper to compensate for them and maintain the course. Calculations have been made and the range of forces found seems acceptable.

Keywords: Fluid mechanic, foil, Ansys

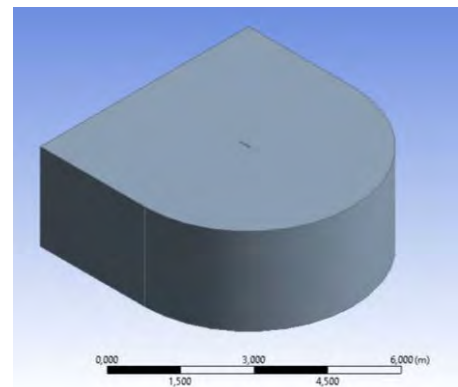

Boat, foil and numerical model

Contact : salome.bru@etu.umontpellier.fr

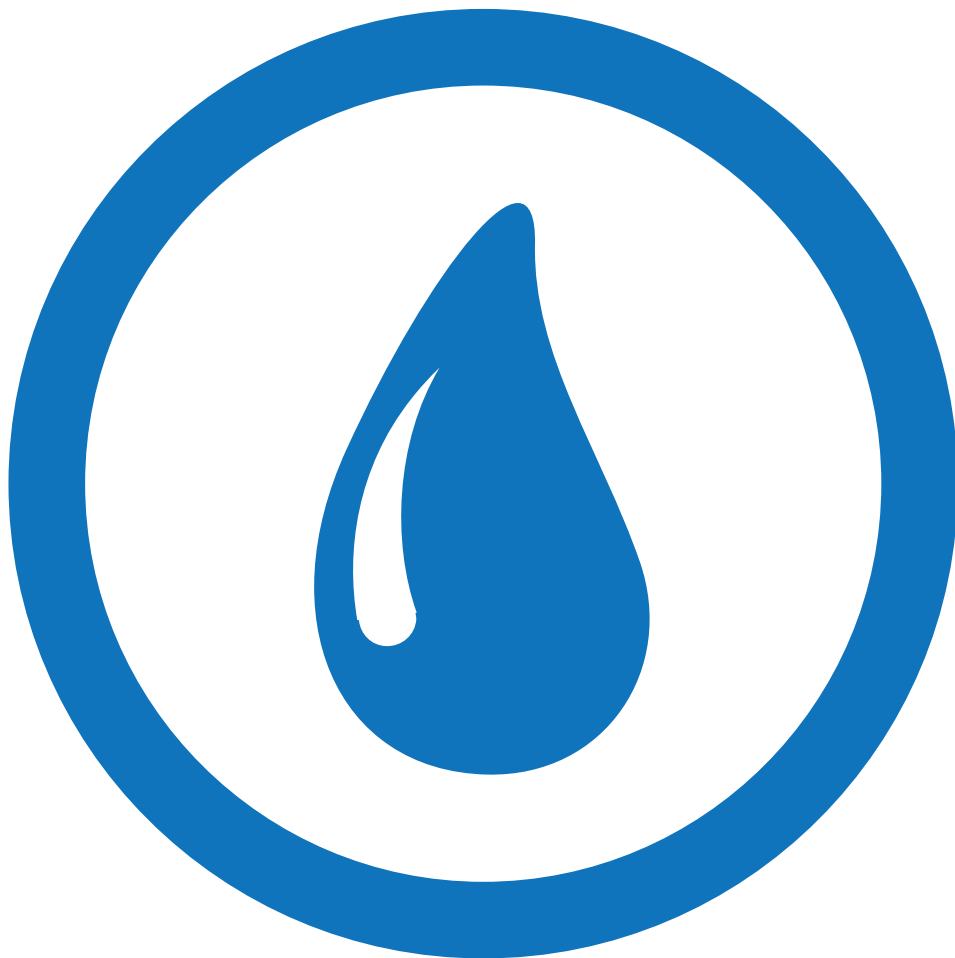

2D Modelling of urban flow

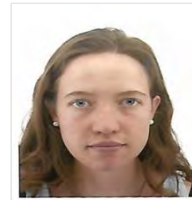

TENET Amélie

Water Science and Engineering

Amélie Tenet

Academic supervisors: P. Finaud-Guyot / V. Guinot



HydroSciences Montpellier

Objective/Motivation:

Having a good knowledge of urban flooding is important in order to reduce human and material damages. The goal of this work is to study if the calculation code SW2D, developed by Hydrosciences Montpellier, is able to calculate the flow in a complex network of urban crossroad. For this purpose, the experiment using the Icube urban flood experimental rig built by ICUBE laboratory will be exploited.

Results:

The results calculated by SW2D code for one crossroad show that only one parameter has an influence on the flow in the crossroad which is the downstream limit condition whereas the mesh and the friction have not. The modelling of the entire model shows that some adjustment must be realised on the downstream limit condition to obtain simulated result close to the experimental result.

Keywords: Hydraulic modelization, urban model of ICube lab, SW2D calculation code

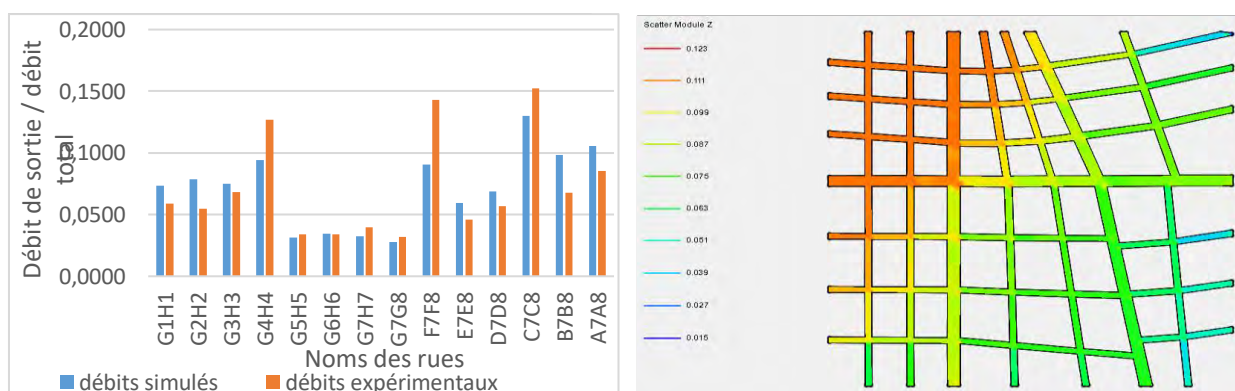

Difference between model results and experimental results for the flow (left) and model result of the water level in the entire district (right)

Contact : amelie.tenet@etu.umontpellier.fr

Evaluation and optimization of an electrochlorination cell



François Pantel

Water Science and Engineering

François PANTEL

Academic supervisors: F. Zaviska



Institut Européen des Membranes

Objective/Motivation:

Objective of the project is to characterize an electrical cell which produce chlorine through chemicals reactions between electrons, water and salt. The idea of electrochlorination appeared in the 90's to avoid transport, storage and handling of chlorine, a toxic chemical element. The study will be conducted through a design of experiments, an ordered series of tests, each one allowing the acquisition of new knowledge to obtain results validating a model with a good economy of means

Results:

The design of experiments is completed and it gives the knowledge of the reaction of the cell for a wide range of values. It is now possible to obtain without doing any experiment the chlorine production or the energy consumption of the cell. Results shows that the efficiency of the reaction is quite low, about 30% on average. To get further, it can be added that the device used isn't perfect for fast rate of flow, so it should be interesting to study this point.

Keywords: eletrochlorination, chlorine production, design of experiments (DOE),

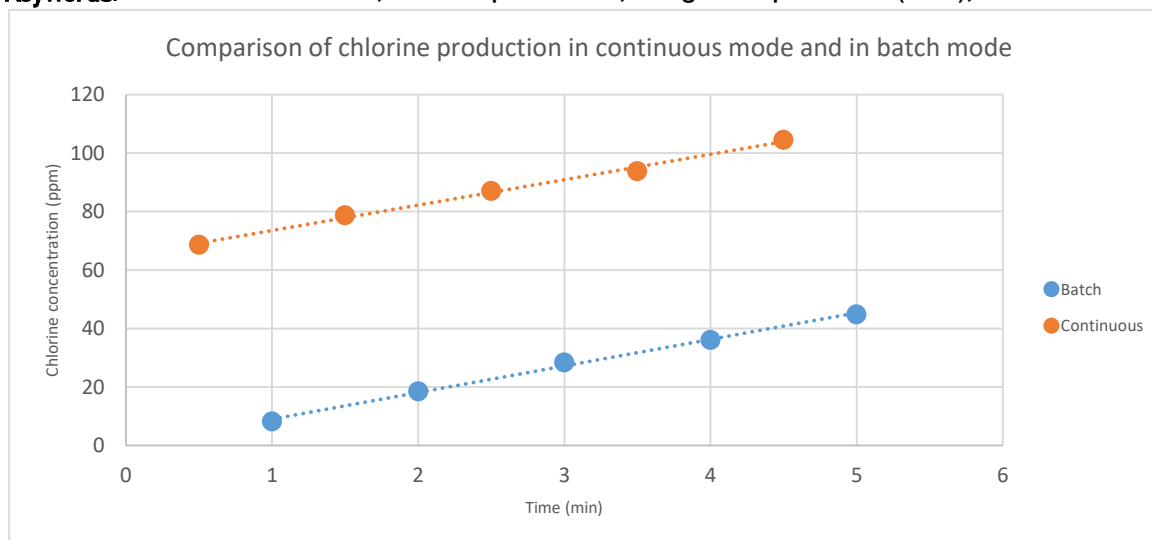

Example of an experiment and the results

Contact : francois.pantel@etu.umontpellier.fr

Lez sculpin populations survey and habitat characterization



Robin REGUIG

Water Science and Engineering

Robin Reguig

Academic supervisors: Catherine Aliaume /
Estelle Masseret



Aquascop / Marbec

Objectives/Motivation:

Define the spatiotemporal variability of the Lez sculpin populations. Establish a link between this variability and the physical and physico-chemical characteristics of the habitat and define what effects on restoration actions. Adapt the MAI method (Morphodynamic Attractiveness Index) to value the potential habitat.

Results:

The Lez sculpin population has been declining since 2001. The trend has reversed since 2016, after restoration actions. The results of the statistical analysis shows that there is link between the variables characterizing the habitat of the sculpin and the population density. A model has been built to calculate a habitat score based on these variables. The score is pretty coherent, when a lot of Lez Sculpin are observed in the river, the score calculated is high. This model can be improved by building it with more data and could be an alternative to the IAM.

Keywords: Lez Sculpin, habitat, Morphodynamic Attractiveness Index



Lez Sculpin

Contact : robin.reguig@etu.umontpellier.fr

Positive Energy WasteWater Treatment by Anaerobic Membrane Bioreactor



CONDE HUAYCHA
Sergio David

Water Science and Engineering

Sergio David
CONDE HUAYCHA

Academic supervisors: Marc HERAN



Polytech Montpellier / IEM

Objective/Motivation:

The Granular Anaerobic Membrane Bioreactor (G-AnMBR) is a promising solution for energy-positive wastewater treatment plants. Indeed, the coupling of anaerobic digestion and membrane units make it possible to obtain high quality water and, in parallel, to produce CH₄ to generate energy.

The European Institute of Membranes aims to carry out a French expertise on the G-AnMBR process. For this purpose, a thesis project started in 2019. The implementation of two Upflow Anaerobic Sludge Blanket (UASB) pilots was the first step of this project. The objective of this study was to acclimatize the granular sludge with the parameters of the future pilot of G-AnMBR.

The monitoring over a period of 38 days and the evaluation of the performance of these UASB pilots were the objectives of this end-of-study project.

Results:

The tests were carried out during 4 periods with Hydraulic Retention Time (HRT) and temperature variations. The HRTs were 80h for the period 1 and 2, 40h for the period 3 and 20h for the period 4. The temperatures were 30 °C for the period 1 and 25° C for the rest of the periods.

The results obtained show that the COD removal efficiency and the methane yield vary according to the hydraulic retention time and temperature.

During the last stage of the tests, the average COD removal efficiency was $68 \pm 12 \%$ and $79 \pm 10\%$ for the RG and RD reactors, respectively. These results are quite similar to the findings of (Risvi et al., 2015) who obtained a performance higher than 80% for a pilot at 20°C and 12h oh HRT.

The average methane yield was 0.17 ± 0.03 and 0.12 ± 0.03 NL CH₄/ g COD removed for the RG and RD reactors, respectively. These results are lower than the findings of (Agrawal et al.,1997) who obtained about 0,21 NL CH₄/ g COD removed for a pilot at 25° C and 9h of HRT.

Keywords: AnMBR, Anaerobic Digester, UASB, DDRS

*a). Influent COD and Effluent COD and COD removal (Reactor RD)
b) Methane Yield and Loss of Methane in the effluent (Reactor RD)*

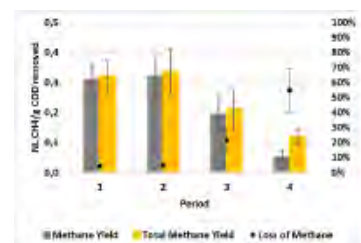
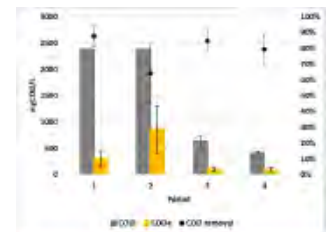

Contact : sergio.conde345@gmail.com

The effect of different sizes of activated carbons on membrane fouling

Water Science and Engineering



Amirah BINTI AMIR

Amirah BINTI AMIR



Academic supervisors: JP. MERICQ / J. MENDRET

Institut Européen des Membranes

Objective/Motivation:

Ultrafiltration has numerous advantages in water treatment. However, membrane fouling remains a major problem in the industry. The effect of different sizes of activated carbons on membrane fouling and the cake layer resistance had been studied using 1g/L of bentonite suspension at a constant pressure.

Results:

The addition of activated carbons shows a remarkable results in reducing membrane fouling and the cake layer resistance, notably when using powdered activated carbons. It is found that the smaller the diameter of activated carbons used, the more the alleviation of membrane fouling is observed.

Keywords: membrane fouling, cake layer resistance, activated carbons

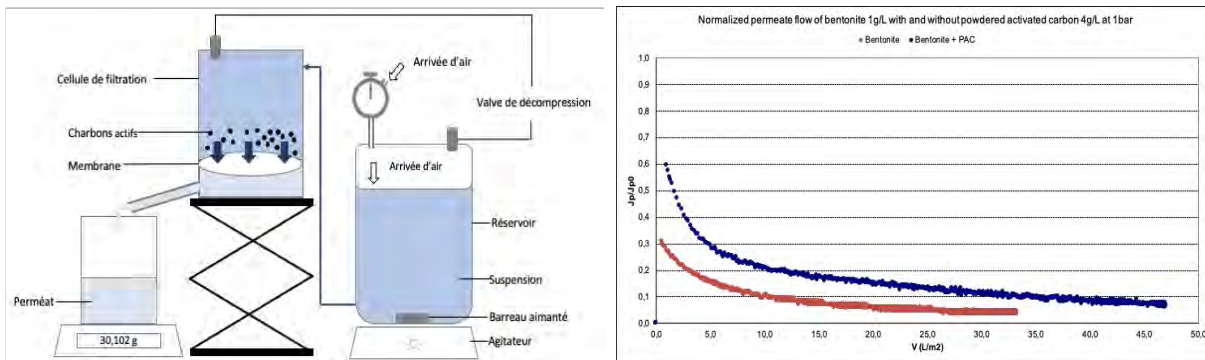

Membrane filtration setup

Contact : amirah.binti-amir@etu.umontpellier.fr

Photocatalytic membrane for filtration and reuse of urban wastewater: evaluation of the degradation potential of membrane biofouling



Audélie Lang

Water Science and Engineering

Audélie Lang

Academic supervisors: C. Faur / L. Soussan



Institut Européen des Membranes

Objective/Motivation:

This subject deals with the bactericidal effect of a PVDF-TiO₂ membrane irradiated by Uvs and its possible use to reduce biofouling during water filtration.

Results:

Results show that there is a bactericidal effect of the irradiated PVDF-TiO₂ membrane, During the filtration, the flow of a bacterial suspension filtrated on this membrane was higher when the membrane was irradiated by Uvs, Nevertheless, this result seems to be attributed to an increased hydrophilicity of the membrane when exposed to UVs rather than to its bocial action,

Keywords: Membrane, filtration, bactericidal effect

*Filtration assembly*

Contact : audelie.lang@etu.umontpellier.fr

Development of a pedagogical manipulation for the hydraulics spe



Augustin Chereau

Water Science and Engineering

Augustin Chereau

Academic supervisors: V. Guinot / S. Majdalani



HydroSciences Montpellier/ Polytech Montpellier

Objective/Motivation:

Validate the capacity of the SW2D modelling software to describe a transient in an urban environment by comparing it to experimental observations over a scale model.

Results:

The simulation produces results on the water height and the propagation speed of the jump which are in agreement with the experiment. The calculation method is correct. Moreover, the duration of the calculation time is largely due to the determination of the initial flow conditions, i.e. the velocity vectors and water height for each cell of the grid

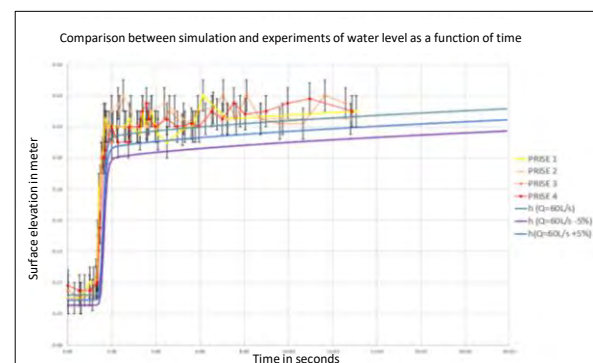

Keywords: Free surface hydraulics, urban area, modeling tool

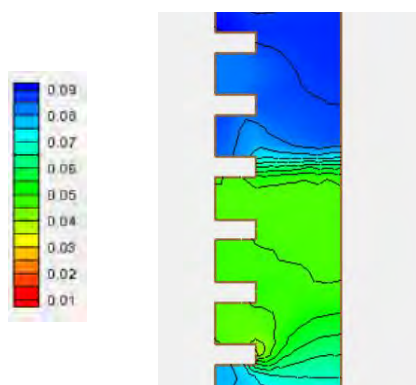

Scale model of a series of idealized buildings / Channel used for experiments

Contact : augustin.chereau@etu.umontpellier.fr

Optimization of coagulation and electrocoagulation process for

Water Science and Engineering



Aymeric Safir

Aymeric Safir



Institut
Européen des
Membranes

Academic supervisors: François Zaviska /
Jean-Pierre Méricq

Institut Européen des Membranes

Objective/Motivation:

This project aims to reduce the coagulant consumption of the process and then the operational costs. The study focuses on an environment acidification during the coagulation to limit the oxidation reactions of metallic ions, improving the coagulation.

Results:

Two colloidal solution (paint and bentonite) was tested on Jar-Test with ferric chloride as coagulant. The paint assays shows a little efficiency gain ($\approx 1\%$) with acid adding during coagulation. But bentonite assays are more eloquent with more than 10% gains reported.

Keywords: coagulation, optimization, acidification, compartmentalized electrocoagulation

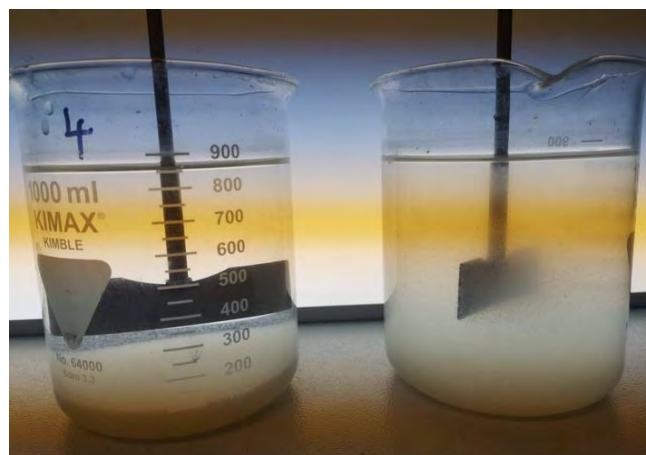

Solution after 10 min settling with acidification during coagulation (left) and without (right)

Contact : aymericsafir@gmail.com

Study of performance's urinal grind wood developed by SANISPHERE



Water Science and Engineering

Clovis BOURIOL



Academic supervisors: Marc HÉRAN

Institution : POLYTECH / Company : SANISPHERE / Laboratory : IEM

Objective/Motivation:

As part of decentralised treatments with separation at the source, Sanisphère develops urinals with shredded wood. This composting is based on the contribution of a nitrogen substrate, here urine, on a carbon substrate mixed with fresh grinding and mature compost. The combination of the urine and the type of support makes it possible to nitrify the nitrogen. This project consists of following nitrogen forms and concentrations over time on four types of woods.

Results:

This study made it possible to emphasize the value of using a shredded wood already watered by urine for a long time. In fact, unlike recent wood, it is used to treat ammonium in urine as well as COD. This is due to the presence of aerobic nitrifying bacteria and able to oxidize biodegradable organic compounds that have developed.

Keywords: Decentralized treatment, separation at the source, valorisation, urinal, shredded wood, urine, nitrogen, nitrification, DDRS.



	Concentration en mg/L					
	DCO	N-NH4+	N-NO2-	N-NO3-	N-NH3	NT
Input	5986	6150	0	0	0	6150
Output	1211	2901	643	2411	0	5955
% treatment	80	53				

Contact : clovis.bouriol02@gmail.com

Urine recycling by Electro-Chlorination: study of a compartmentalized cell coupling chlorination and membrane process

Water Science and Engineering

Enzo COLLOMBAT

Academic supervisors: F. Zaviska / M. Heran



Européan Institute of Membranes / WeCo Company

Objective/Motivation:

The WeCo company is using a classic electro-chlorination process to treat organic and nitrogen pollution and create autonomous toilets. The purpose is to improve the process with a compartmentalized technology which works with membranes. In this way, we can produce free chlorine to treat pollution and recycle toilet flushes. The process had been tested in terms of nitrogen and organic pollution reduction.

Results:

The new process is effective on Nitrogen pollution but struggle with organic pollution. The classic electro-chlorination permit to reach best faradic yield. In this way, we can reduce the processing time and spend less energy. Moreover. The compartmentalized technology is far more expensive because it needs membranes and more titanium.

Keywords: Electro-chlorination, Nitrogen and Organic pollution, autonomous toilets, DDRS

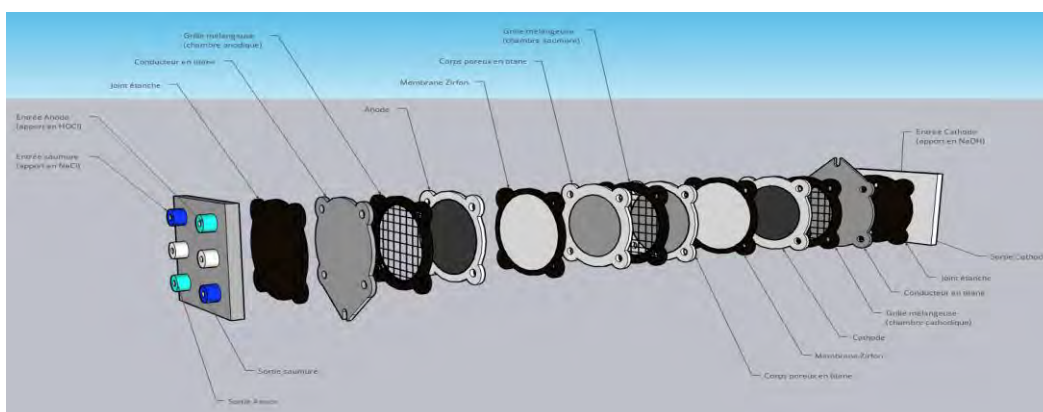

Compartmentalized Cell of electro-chlorination

Contact : enzo.collombat@etu.umontpellier.fr

Study of ichthyologic diversity in mediterranean lagoons

Water Science and Engineering

Etienne Dayet

Academic supervisors: C. Aliaume / E. Masseret



MARBEC / University of Montpellier

Objective/Motivation:

Analysis of lagoon typology (Multiple Correspondances Analysis) and characterisation of fish assemblage using hierarchical classification and MultiDimensional Scaling. Establishing correlation between fish communities and environmental characteristics.

Results:

Correlation between depth and chlorophyll a concentration, and between surface and anthropogenic pressure. Definition of lagoon groups using surface, depth and anthropogenic pressure. No distinct groups of lagoons when looking at fish assemblage, but rather a variability continuum depending on geographical location of lagoons.

Keywords: Ecology, environment, statistics, lagoons, fish communities.

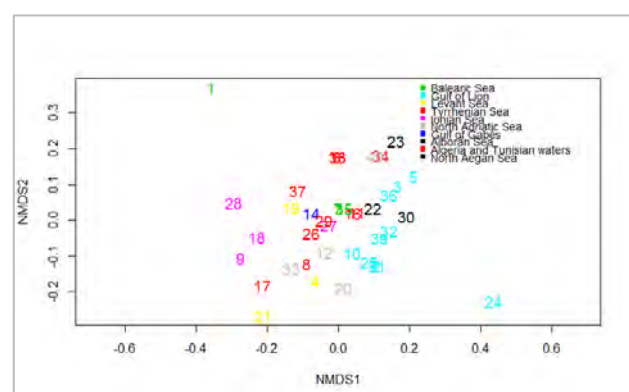
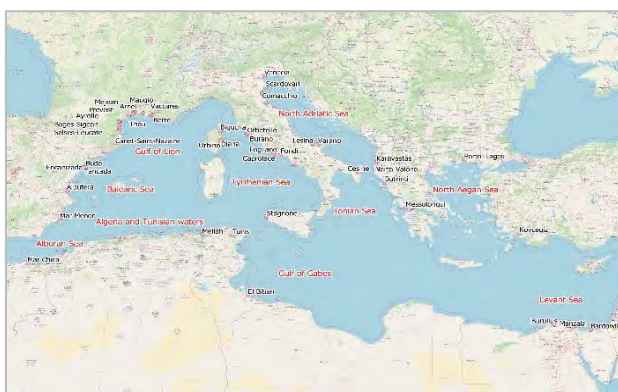

Contact : etienne.dayet@etu.umontpellier.fr

Automation of data processing in the context of marine environmental

Water Science and Engineering

Isaure VALADIER

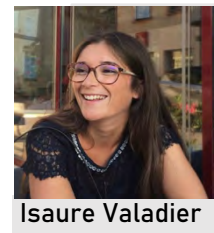

Isaure Valadier



Créocéan

Academic supervisors: B. BEC

Objective/Motivation:

Objective of the project is to automate two Excel files that gather marine environmental monitoring data. The first file contains 31 years of monitoring of species encountered in the Golfe du Lion. It is composed of the branch, class, family and corresponding genus or species. The second file is composed of the pollutant concentrations at the port of Port-la-Nouvelle.

Results:

The file about benthic species is composed of a repository of species and their associated unique number. It is also composed of a table giving each row data the correct spelling of the scientific name and the associated unique number. The file about the Gulf of Lion is made up of tables all dependent on each other. Créocéan ingenieer's will save time.

Keywords: marine environmental monitoring, benthos, marine sediments, database, raw data, banking, standardization.

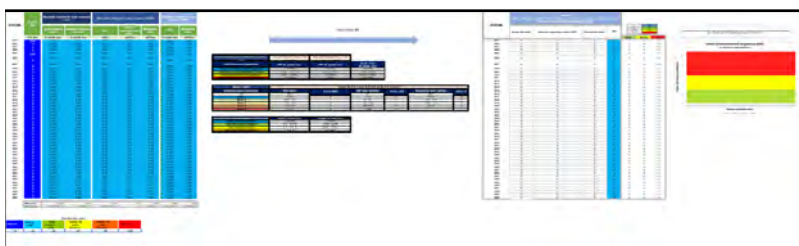

ID corrigé associé à l'espèce	ScientificName_corrigé
988	Serpulidae
985	Sabellidae
982	Terebellidae
981	Ampharetidae
980	Pectinariidae
976	Flabelligeridae
975	Oweniidae
971	Dorvilleidae
967	Lumbrineridae
966	Eunicidae
948	Syllidae

Image d'une feuille de calcul automatique et image du référentiel d'espèces benthiques

Contact : isaure.valadier@etu.umontpellier.fr

Study of mixing in a confluence



Chamboredon
Laurent

Water Science and Engineering

Laurent Chamboredon

Academic supervisors: S. Majdalani



Hydroscience Montpellier

Objective/Motivation:

this project aims to model a confluence situation in order to study its mixing

Results:

Modeling on HEC-RAS is simple and gives convincing results. however, the use of 1D equations does not allow precise monitoring of the mixing at the confluence.

Keywords: Hydraulique ; mixing ; confluence

Contact : Laurent.chamboredon@etu.umontpellier.fr

Monitoring of water quality during the Perols's harbour dragging



Léa Hofer

Water Science and Engineering

Léa HOFER

Academic supervisors: Chrystelle Bancon



HydroSciences Laboratory HSM

Objective/Motivation:

The objective of the project is the monitoring of the water quality during the Perols's harbour dragging from November to December 2020. In 5 points in situ, after measure of physicochemical parameters, filtered water were sampled, then analysed by ICP-MS in the HydroSciences Laboratory.

Results:

The analyses allow to detect potentials pollutions of traces elements as As, Cd, Cu, Ni, Pb or Zn. All the final concentrations of the elements were inferior of concentrations of the references points. The analysis show that the dragging doesn't impact the quality of water.

Keywords: Dragging, water quality monitoring, traces elements, physicochemical parameters, DDRS

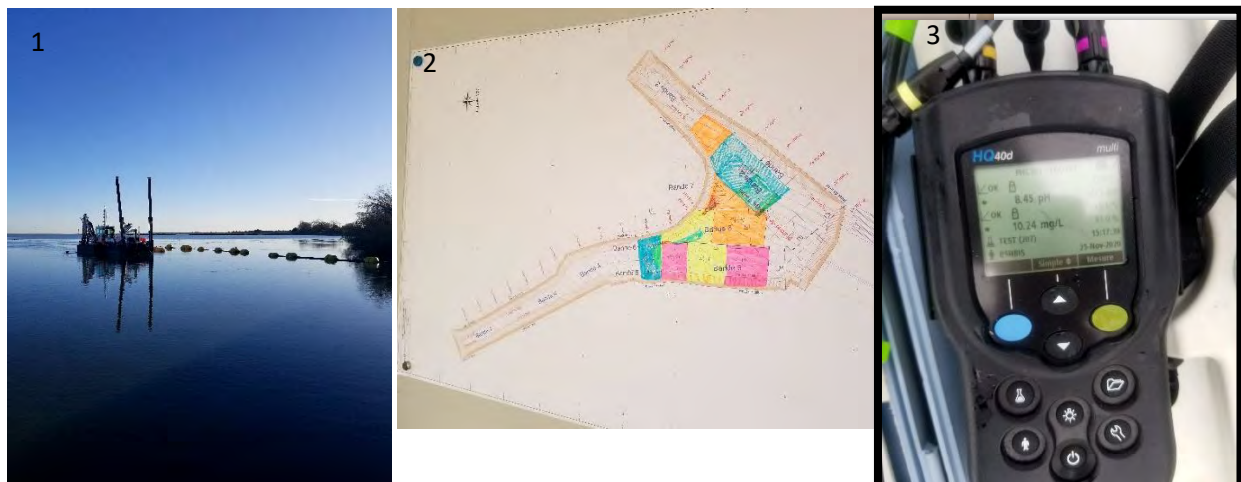

Dredger (1) - dragging plan (2) - Probes of pH, O₂ and conductivity (3)

Contact : lou.06@laposte.net

Sewage sytem alert protocol

Water Science and Engineering

Marlène GIEULLES



SAUR COMPANY

Academic supervisor: D. BOUYER

Company supervisor: C.LARGUIER

Objective/Motivation:

The nature of domestic and industrial effluents is becoming more complex and hazardous for environment. So it's necessary to know how to react in accidental pollution of the sewage system by quickly finding suitable solutions, in order to avoid deterioration of the receiving environment and a negative impact on downstream users of the discharge from the wastewater treatment plant.

Results:

An alert protocol is being implemented at SAUR and is personalized for each site in order to be able to have specific indications of the sewage system and its environment. He determines the solutions for each incident that may arise. The procedure to follow is detailed in order to know exactly all the recommended steps. A possible improvement could be to create a software that list all the data of sanitation systems in France.

Keywords: sewage system, alert protocol, industrial discharge, pollution management

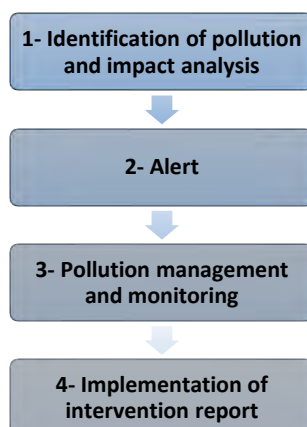

Different steps of the alert protocol and a solution of flotting dam to contain pollution

Contact : gieulles.marlene@hotmail.fr

Sensitivity of the response of an urban catchment to precipitation



Nathan POMEYROL

Water Science and Engineering

Nathan POMEYROL

Academic supervisors: Christian SALLES /

Luc NEPPEL



HydroSciences Montpellier

Objective/Motivation:

The objective of this project is to analyse the influence of the rainfall spatial variability at the scale of an urban catchment. As rainfall is often considered as constant over a modeled catchment, this study tests the assumption's justification. Are mistakes being made when modeling rainfall as constant ? Can model's results be trusted ?

Results:

The influence of rainfall spatial variability is studied through the analysis of simulations carried out on the PCSWMM modeling software. The hydrograph generated by the software vary slightly according to different configurations of hyetograms used as input of the model. The runoff volume mostly and the peak flow are influenced by the rainfall spatial variability. However, the obtained results when considering the rainfall as constant are close enough to what is obtained when considering the rainoff spatial variability to keep using the assumption when modeling hydrological models.

Keywords: Hyetogram; hydrograph; urban catchment; spatial variability; hydrological modeling

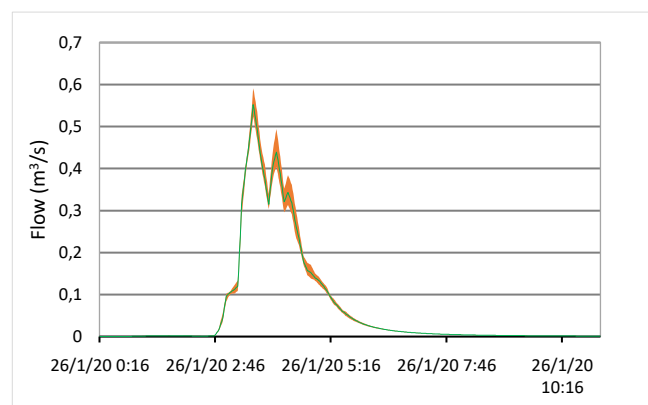
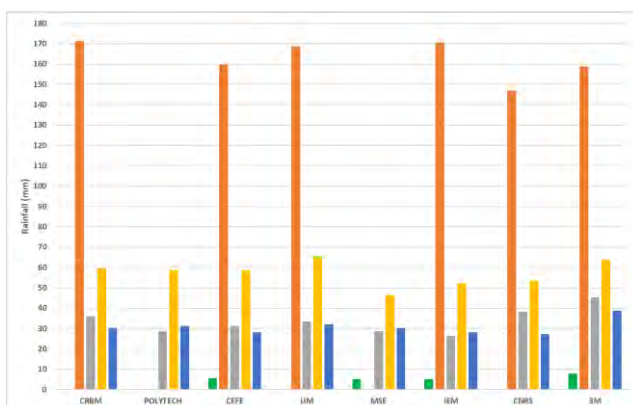

Left : Rainfall for the five rainy episodes studied according to different pluviographs ; Right : Average hydrograph for the event of January 26 (green) and variations of this hydrograph considering the rainfall spatial variability (orange)

Contact : nathan.pomeyrol@etu.umontpellier.fr

Comparison of modeling approaches for hydraulic structures



Niels Vasselin

Water Science and Engineering

Vasselin Niels

Academic supervisors: P. Finaud-Guyot / S. Majdalani



Polytech Montpellier / Université de Montpellier / HSM

Objective/Motivation:

The goal of this project was to compare to way of water flow modeling. First with the software Hec-Ras and then with the flux closures and source term models for shallow water models with depth-dependent integral porosity.

Results:

At the end of this project it appear that the software is easier and quicker to uses werehas the calculs way can be more precise as soon as you are able to handle it

Keywords: Shallow water flow; Hec-Ras; porosity models; hydraulic; bridge

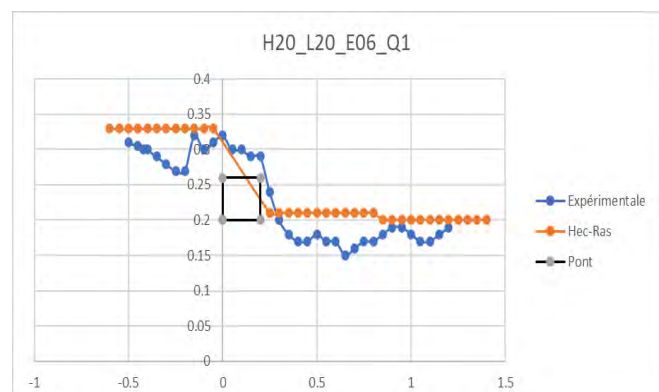

Experimental and modeled water flow

Contact : niels.vasselin@etu.umontpellier.fr

Ozone diffusion through membrane contactor for micropollutants elimination



Simon ROSE DAVID

Water Science and Engineering

Simon ROSE DAVID



Academic supervisors:

S.Brosillon / J.Mendret

European Institute of Membranes

Objective/Motivation:

Over the last few years, the norms regarding water quality have evolved and many compounds found in water are targeted. Micropollutants are part of these compounds since they have an impact on the environment at a very low concentration. Thus, membrane contactor represent a cost-effective and flexible alternative to the already existing treatments. This project seeks to study the behavior of this kind of treatment by using an experimental pilot.

Results:

Through several experiments, it is possible to see that ozone is first dissolved very quickly in water until it reached a plateau. The mass transfert coefficient and the solubility ratio found were similar to those found in previous works. However, experiments with a dye (Acid Orange 7) and carbamazepine showed that another formula with a consumption term is needed to calculate these coefficients.

Keywords: material balance, membrane contactor, micropollutants, ozonation



Pictures of the experimental pilot (only the pilot on the left, and the whole pilot with the complete gas system on the right)

Contact : simon.rose-david@etu.umontpellier.fr

Simulation of runoff on cultivated plots

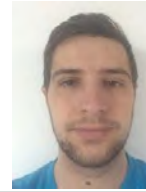

THOMAS
POURCHAILLE

Water Science and Engineering

Thomas Pourchaille



Academic supervisors:

V.GUINOT /
P.FINAUD-GUYOT

HydroSciences Montpellier and LISAH Laboratory

Objective/Motivation:

From a digital working model (DTM), two models were generated in order to interpolate this DTM differently. The first is a model with topography linearly interpolated on the mesh and the second is a model with topography interpolated by inverse distance weighting at 16 points. The objective of this end of study project is to determine what is the consequence of the interpolation on the hydraulic simulation.

Results:

The linear model generates water depths larger than the other model (red zones figure 2) at the level of the maximum depths (figure 1). Conversely, the inverse distance model obtains higher values than the linear model on the water line crossing the plot (blue line in the center). However, by reducing the precipitation to $1e-7$ m/s, the red zones disappear. So when it comes to heavy precipitation, the linear model overestimates or the inverse distance model underestimates the water depth.

Keywords: Porosity model, free surface hydraulic, simulation and 2d modeling

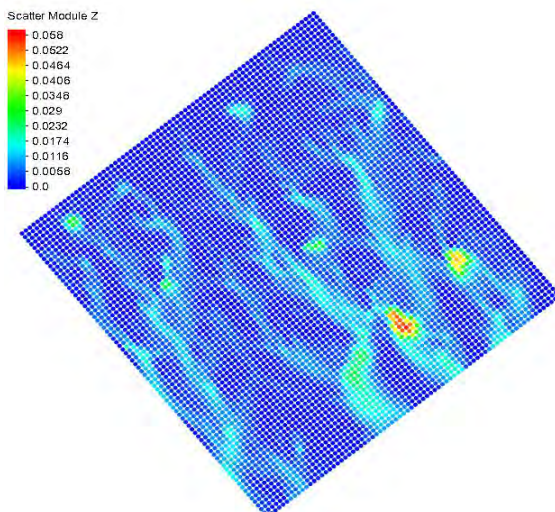

Figure 1 : Simulation of the water depth on the linear model for a precipitation of $1e-6$ m/s

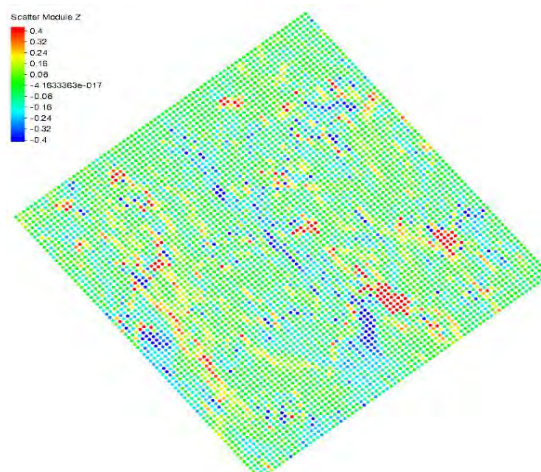

Figure 2 : comparison of the simulation of the water depth between the two models for a precipitation of $1e-6$ m/s

Contact : thomas.pourchaille@etu.umontpellier.fr

Hydraulics Modeling



Werda ADEM

Water Science and Engineering

Werda ADEM

Academic supervisors: M-G TOURNOUD



Hydraulics unit, SAUR company

Objective/Motivation:

The first goal of this project was to comprehend how a hydraulic model is created and functions using the american software **EPANET**. It is also to understand how the model is calibrated volume and pressure wise in order to simulate as precisely as possible real life events. Secondly, this project studies the three headloss formulas (Darcy-Weisbach, Hazen-Williams, Chezy-Manning) presented by the software to see if the choice of the headloss formula has a significant impact on the model's results.

Results:

The experience was to compare the behavior of the hydraulics model using the 3 headloss formulas to the pressure mesured on the field while opening 6 fire hydrants to create major pressure drops. The graphic below shows that the results of the 3 models are quite similar to one another and that all three headloss formulas produce results that are accurate and applicable to the hydraulic studies done by the company.

Keywords: Hydraulic modeling, EPANET, Potable water system, Headloss, Darcy-Weisbach, Hazen-Williams, Chezy-Manning

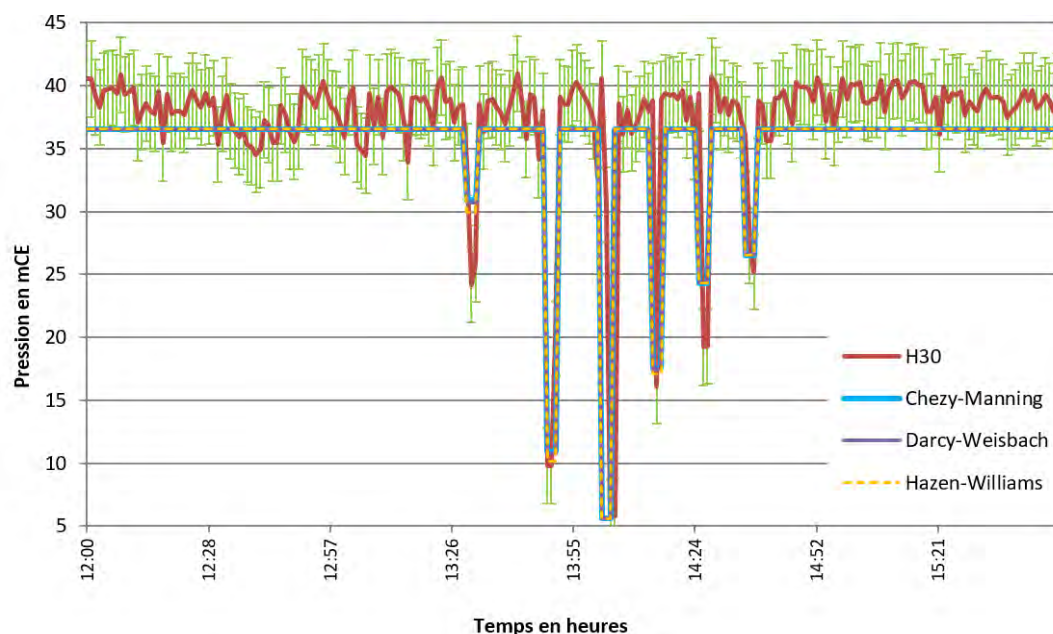

Graphic comparing the pressure mesured on the field and the pressure calculated by EPANET using the 3 different headloss formulas.

Contact : werda.said98@gmail.com

Tracking of Vinyl Chloride Monomer In Drinking Water Distribution Network



Mira MAHDI

Water Science and Engineering

Mira MAHDI

Academic supervisor: Marie-George TOURNOUD



VEOLIA EAU

Objective/Motivation:

Vinyl chloride monomer is a carcinogenic compound used in the polymerization of polyvinyl chloride for the manufacture of pipes. Those that were manufactured before 1980 and due to a lack of knowledge on the subject back then release VCM into water posing a risk for consumers health. To ensure that their distributed water is within standards, *Eau de Nîmes Métropole* have set up semi-annual campaigns to monitor the concentration of VCM in the pipes of its municipalities. 96 sampling points are chosen in zones with a high risk of contamination using a Geographic Information System.

Results:

Following sampling and analyses, all sampling points were within the norms. Nonetheless a study of adapted solutions takes place in case of a non compliance. These may involve purges, tubing of pipes as well as renewal of parts of the network.

Keywords: Vinyl chloride monomer, quality threshold , purges, tubing, drinking water.



On the left the instrument used for stripping VCM out of water, on the right a map of *Nîmes Métropole* showing the concentration of VCM found at the sampling points

Contact : miramahdi97@gmail.com

Influence of pollutants on 3 fish populations *Gambusia affinis*

Water Science and Engineering

Ambre ROZAND

Academic supervisors: E. Farcy



MARBEC

Objective/Motivation:

The objective of this project is to determine if there is a pollutant-induced influence on hepatic detoxification mechanisms on 3 populations of gambusia *Gambusia affinis*. Populations come from the Camargue channels, Étang de l'Or and from university Paul Valéry. Different populations were exposed to different pollutants (betanaphthoflavone, oxadiazon, bentazone and azoxystrobin) at different concentrations, ecologically relevant. The EROD and GST activity was measured to determine the hepatic detoxification response to these substances.

Results:

The analyses show a male/female differentiation but also a distinction between populations from a polluted environment and those from a healthy environment.

Keywords: *Gambusia affinis* ; pesticide ; EROD ; GST ; Camargue



Picture of Gambusia Affinis

Contact : ambre.rozand@etu.umontpellier.fr

Ecophysiological approach of *Picochlorum*, *microalga* responsible for green water in Thau lagoon

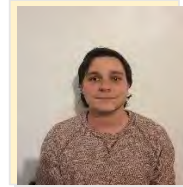

Anthony Bof

Water Science and Engineering

Anthony BOF

Academic supervisor : Beatrice BEC



Ifremer Sète

Objective/Motivation:

Picochlorum is a microalga responsible for a phenomenon of green waters in Thau lagoon that began in September 2018, following an anoxic event called "malaigue" (bad water in occitan), and has continued through the whole winter period which is unusual. It has caused important mortality within mussels and oysters cultures and consequently high economical losses for Thau shellfish farmers. The objectives of the project were to study *Picochlorum's* physiology through its nitrogenous nutrition, mixotrophic potential, low temperature tolerance and its ability to survive anoxia in order to understand why *Picochlorum* has bloomed.

Results:

Picochlorum has several competitive advantages that can explain its bloom. During the project, we demonstrated that it is able to use multiple sources of nitrogen, both mineral (ammonia and nitrate) and organic (urea) sources. *Picochlorum's* mixotrophic potential has been proved to be important through the study of cultures upon glucose enriched mediums. Growth has been observed both in cultures at 12 and 24 °C which corresponds to winter and summer temperatures respectively observed in Thau lagoon. Ethanol and acetate productions have been quantified in anoxic conditions, meaning *Picochlorum* has metabolic fermentation pathways and can survive limited anoxia.

Keywords: *Research, Picochlorum, microalga, green algae, ecophysiology*

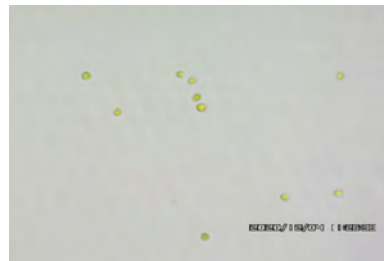

Picochlorum , photonic microscopy, 1000x magnification

Contact : anthony.bof@gmail.com

PERFORMANCE ANALYSIS OF A NEW ULTRAFILTRATION MEMBRANE

Water Science and Engineering



Emile GONNET

Emile GONNET



Academic supervisors:

Marc Héran /
François Zaviska

Polytech Montpellier/ Institut européen des membranes

Objective/Motivation:

The aim of this project is to characterize a new ultrafiltration membrane before using it in real conditions. Several solutions and clogging suspensions are filtered in order to observe the resistance of the membrane to clogging. The parameters studied will be the initial permeability, the evolution of the permeate flow during filtration at constant pressure and the efficiency of backwashing and various washes. The results will be compared with the same tests on the Kubota membrane that having similar properties and already available on

Results:

The performance of the new Amogreentech membrane is overall better than Kubota membrane. On the test in real condition with waste water, we observe that the new membrane is less sensitive to clogging caused by organic particles which is important in water treatment.

Keywords: UF membrane, permeability, frontal filtration, clogging

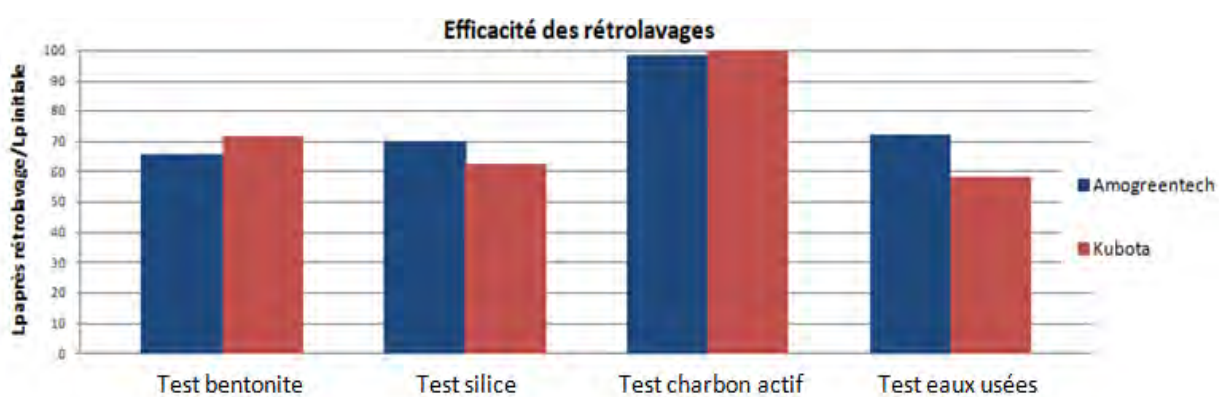

Efficiency of backwash test

Contact : emile.gonnet@etu.umontpellier.fr

Analysis of the diversity of phytoplankton communities (> 20 μm) in the northeast of Brazil

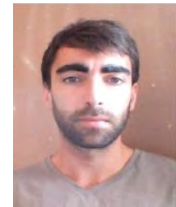

G. GOBINET

Water Science and Engineering

Gabriel Gobinet

Academic supervisors: Béatrice Bec



UMR MARBEC (Montpellier)

Objective/Motivation:

The objective of this study is to characterize phytoplanktonic communities of the northeast of Brazil, and to demonstrate the power of the Sanders index. Only the microphytoplanktonic fraction was studied (between 20 and 200 μm). In that aim, Sanders index have been calculate on these communities and compared to abundances and occurrences previously calculated. Then, a dominance rank have been established.

Results:

This study relies on abundance and occurrence parameters and showcase the power of Sanders index in order to establish dominance classifications in these communities. Finally, analysis showed a dominance of several diatoms and flagellates genders, but also the dominance of a taxonomic unit belonging to cyanobacteria, *Oscillatoriales*.

Keywords: DDRS, micro- phytoplankton, Sanders index, Brazil, abundances, occurrences



Photo caption: Oksana & Max St John

Contact : gabriel.gobinet@etu.umontpellier.fr

Performance of composite hollow fiber membrane (PVDF-TiO₂) for water treatment



Maria Ines
BURGOS

Water Science and Engineering

Maria Ines BURGOS



Academic supervisors: Julie MENDRET /
Jean-Pierre MÉRICQ

Institut Européen des Membranes

Objective/Motivation:

In this study, the effects of photo-induced hydrophilicity on pure water flux behavior of two PVDF-TiO₂ hollow fiber membranes were investigated thoroughly by means of photo-filtration. These membranes composed of 10 and 58 fibers containing TiO₂ particles have been exposed to different light intensities from a UV lamp and a LED fabric

Results:

It was been shown that PVDF-TiO₂ membranes became more hydrophilic under the effect of UV irradiation. The increased hydrophilicity was responsible for the rise in pure water flux during photo-filtration. Fig.1 shows the flux behaviour of PVDF-TiO₂ membranes (composed of 58 fibers) at various irradiances : 1 ;1,9 and 2,5 mW.cm⁻², only the highest intensity allowed a super-hydrophilic effect to be observed.

Keywords: Composite membranes; Hollow fiber membranes; Photo-filtration, Hydrophilicity

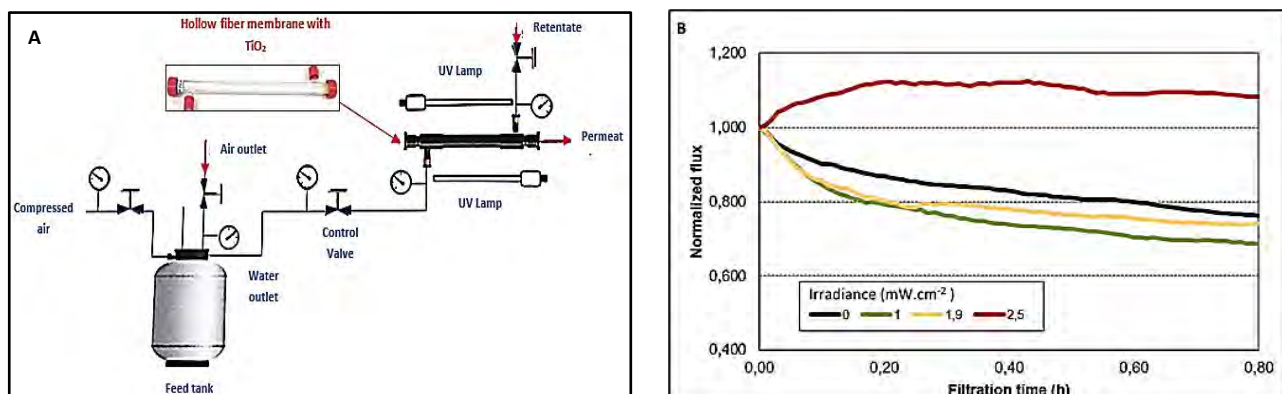

Fig. 1 : A- Frontal filtration system equipped with UV irradiation ; B- Permeate flux of PVDF-TiO₂ during photo-filtration at various irradiances

Contact : m.27burgos@mail.com

Retour D'expérience Hydrologique : Crues de l'Hérault, du Gardon et affluents



Mehdi Ezzenfari

Water Science and Engineering

Mehdi Ezzenfari

Academic supervisors: L. Neppel / G. Ferry



Predict Services

Objective/Motivation:

The 19 September 2020 a flash food occurred on the Mont Aigoual area. Precipitation intensity exceeded 100m/h during 3h leading to sever floods for all the mountainous catchment of the area. This study presents a post-flood investigation based on fields investigation and data analysis. The mains objectives are to estimate the catchment's discharge and flood dynamic.

Results:

The upstream Hérault River flooded very quickly, with a rise time of approximately 3 hours. Flood propagation speeds varied from 4.3 m/s upstream to 1.5 m/s downstream. The specific flow rates are of the order of 10 to 25 m³/s/km², see more. These flows are of the same order of magnitude as some estimates made during other French REXs in the south-east, in the Mediterranean region.

Keywords: Mediterranean Episode; Flash flood; Reconstitution of flows; DDRS;

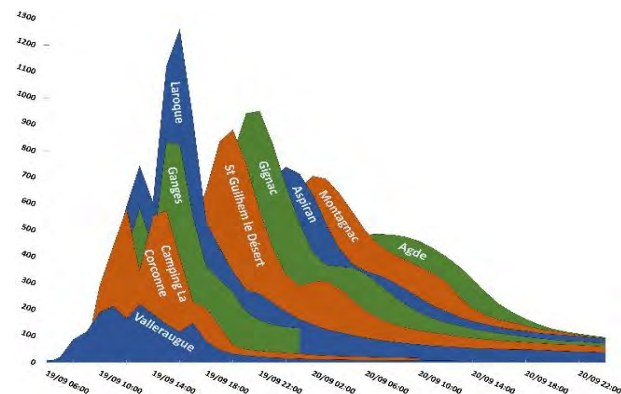

Picture of the flooding of the Gardon at Anduze / Propagation and evolution of the flood on the Hérault river

Contact : ezzenfari.mehdi@gmail.com

Scientific tool and methods used to assess stock of fisheries resources involving fishermen



RACINE Mickael

Water Science and Engineering

Mickael Racine



Planète Mer

Academic supervisors

Catherine Aliaume /
Audrey Lepetit

Objective/Motivation:

Conduct scientifically rigorous studies that reflects the reality of fisheries and the status of stocks of edible sea urchins and red mullet. Break free from the status of 'data-poor' stocks and put in place monitoring methods that allow significant results to be reported in economic (Brexit), social (Sars-Cov-2) and environmental (ocean degradation problems: habitats and biodiversity) contexts that are not supportive to the fishing sector. Involve fishermen in scientific studies by and for them by providing figures to improve the management measures already in place with the aim of perpetuating the activities of artisanal fishermen while preserving marine resources.

Results:

No significant results proving a diminution in sea urchin population in the Var department, necessity of homogeneity and standardization in the field strategy, process about constructing and establishing a poor-data stock assessment with local detailed characteristic of the red mullet population, establishment of a protocol to collect data to assess both the red mullet stock and the influence of fishing activity on it

Keywords: stock, assessment, sea urchins, red mullet, poor-data, fisheries, involving, fishermen, DDRS, PELA-Méd, Planète Mer, CDPMEM Var



Site de l'INPN, Benjamin GUICHARD, agence des aires marines protégées

Contact : mickael.racine@etu.umontpellier.fr

Calibration of the pluviographs network of the HSM "Water in the city" observatory



Water Science and Engineering

Raphaël ROBIN

Academic supervisors: P. Marchand / L. Neppel



Ecole polytechnique universitaire de Montpellier / HydroSciences Montpellier

Objective/Motivation:

The objective of this project is to design and carry out an experimental protocol permitting the calibration of the network of pluviographs of the HydroSciences Montpellier research unit. The goal is to develop a protocol allowing efficient and rapid calibration in order to both calibrate the rain gauges but also to offer a single calibration, common to all the devices.

Results:

The results allowed to establish a calibration for each pluviograph but also to demonstrate the possibility of a single calibration for all the pluviographs. However, the single calibration leads to an increase in uncertainties. A dynamic correction made through a mathematical formula has also been studied and proposed in order to correct and facilitate the processing of future rainfall data.

Keywords: Calibration, Pluviograph, Hyetogram, Rainfall measurement, Water, Rainfall intensity



Pluviograph 6465M and the test bench used to carry out the experimental protocol

Contact : raphael.robin@etu.umontpellier.fr

Wastewater ozonation - formation of bromates

Water Science and Engineering



Salomé SANTIN

Salomé SANTIN



European Institute of Membranes

Academic supervisors: J.Mendret
S. Brosillon

Objective/Motivation:

As micropollutants have become a real scourge for the environment, solutions for eliminating them in wastewater treatment plants are increasingly being studied for environmental purposes or for the reuse of wastewater. In this report, the method studied is ozonation in a semi-batch reactor. The variation of global parameters such as COD, TOC, UV absorbance on water in the treatment plant before and after ozonation will be studied, as well as the formation of bromates.

Results:

Comparison of real water from the WWTP before and after ozonation proves that ozone induces a reduction in organic pollution of around 50%. Because of its oxidizing power and that of the ° OH radicals, formed by its decomposition, ozone therefore allows better purification of wastewater in addition to the removal of a majority of micropollutants. This makes it an ideal tertiary treatment. However, the major disadvantage of ozonation is the formation of toxic by-products, in particular bromates formed by oxidation of bromides. For 1mg/L of oxidized bromides there are 1.5mg/L of bromates formed.

Keywords: Ozonation; hydroxyl radicals; waste-water ; semi-batch reactor; bromates

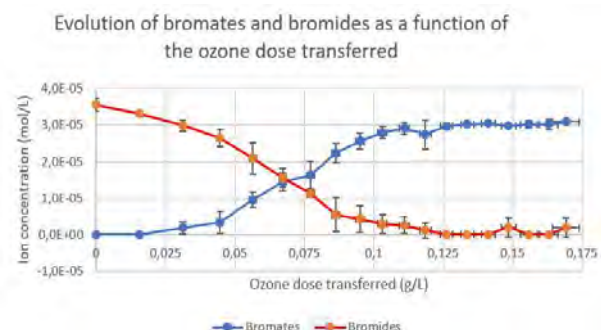

1) Ozonation pilot used for manipulations

2) Graph representing bromates formation and disappearance of bromides as a function of transferred ozone dose

Contact : salome.santin@outlook.fr